



# Answer Wood Stove Owner's Manual

- Freestanding Stove
- Mobile-Home Approved
- Alcove Approved
- Hearth-Stove Approved
- Masonry Fireplace Insert
- Zero-Clearance (Metal) Fireplace Insert

*Save these instructions  
for future reference*

## **SAFETY NOTICE:**

If this appliance is not properly installed, a house fire may result. For your safety, follow the installation directions. Contact local building or fire officials about restrictions and installation inspection requirements in your area.



**TRAVIS INDUSTRIES  
HOUSE OF FIRE**

© Copyright 2007, T.I.  
\$10.00 100-01166  
4050923



Tested to: U.L. 1482

## Introduction

---

We welcome you as a new owner of a Lopi Answer wood-burning stove. In purchasing a Lopi Answer you have joined the growing ranks of concerned individuals whose selection of an energy system reflects both a concern for the environment and aesthetics. The Lopi Answer is one of the finest appliances the world over. This manual will explain the installation, operation, and maintenance of this appliance. Please familiarize yourself with the Owner's Manual before operating your appliance and save the manual for future reference. Included are helpful hints and suggestions which will make the installation and operation of your new appliance an easier and more enjoyable experience. We offer our continual support and guidance to help you achieve the maximum benefit and enjoyment from your appliance.

## Important Information

---

No other Lopi Answer appliance has the same serial number as yours. The serial number is stamped onto the label on the back of the appliance.

This serial number will be needed in case you require service of any type.

Model: \_\_\_\_\_ Lopi Answer ND \_\_\_\_\_

Serial Number: \_\_\_\_\_

Purchase Date: \_\_\_\_\_

Purchased From: \_\_\_\_\_  
\_\_\_\_\_  
\_\_\_\_\_

### **Mail your Warranty Card Today, and Save Your Bill of Sale.**

To receive full warranty coverage, you will need to show evidence of the date you purchased your appliance. Do not mail your Bill of Sale to us.

We suggest that you attach your Bill of Sale to this page so that you will have all the information you need in one place should the need for service or information occur.

**NATIONAL  
FIREPLACE  
INSTITUTE**



**CERTIFIED**  
www.nficertified.org

We suggest that our woodburning hearth products be installed and serviced by professionals who are certified in the U.S. by the National Fireplace Institute® (NFI) as NFI Woodburning Specialists or who are certified in Canada by Wood Energy Technical Training (WETT).



Wood Energy  
Technical Training  
www.wettinc.ca

## **General Information**

|   |   |
|---|---|
| Introduction & Important Information..... | 2 |
| Safety Precautions .....                  | 4 |
| Features & Specifications.....            | 6 |

## **Stove Installation**

|                                       |    |
|---------------------------------------|----|
| Planning The Installation.....        | 7  |
| Floor Protection Requirements.....    | 8  |
| Stove Placement Requirements .....    | 8  |
| Clearances .....                      | 8  |
| Chimney Requirements .....            | 10 |
| Chimney Termination Requirements..... | 11 |
| Outside Air Requirements .....        | 11 |
| Alcove Installation Requirements..... | 12 |
| Mobile Home Requirements .....        | 13 |

## **INSTALLATION DIAGRAMS**

|   |    |
|---|----|
| Standard Ceiling with a Factory Built Chimney.....  | 14 |
| Cathedral Ceiling with a Factory Built Chimney..... | 14 |
| Exterior Factory Built Chimney .....                | 15 |
| Hearth Stove Positive Connection.....               | 15 |
| Hearth Stove Direct Connection .....                | 16 |
| Interior Masonry Chimney .....                      | 16 |

## **Fireplace Insert Installation**

|   |    |
|---|----|
| Planning The Installation.....                        | 17 |
| Preparation for Installation .....                    | 17 |
| Additional Accessories Needed for Installation....    | 17 |
| Installation Considerations.....                      | 17 |
| Fireplace Requirements.....                           | 18 |
| Insert Placement Requirements.....                    | 19 |
| Hearth Requirements .....                             | 19 |
| Masonry Fireplace Requirements .....                  | 19 |
| Zero-Clearance (Metal) Fireplace Requirements .....   | 20 |
| Drafting Performance .....                            | 20 |
| Leveling Bolt Installation .....                      | 20 |
| Block-Off Plate Installation .....                    | 21 |
| Insert with Positive Connection.....                  | 22 |
| Insert with Direct Connection (Masonry Fireplace).... | 22 |
| Insert with Direct Connection (Z.C. Fireplace).....   | 23 |
| Insert with Face Seal Connection.....                 | 23 |

## **Operating Your Appliance**

|                                 |    |
|---------------------------------|----|
| Safety Notice.....              | 17 |
| Before Your First Fire.....     | 24 |
| Opening the Door.....           | 24 |
| Starting a Fire.....            | 25 |
| Adjusting the Burn Rate.....    | 26 |
| Ash Removal.....                | 26 |
| Optional Blower Operation ..... | 27 |
| Re-Loading the Stove.....       | 27 |
| Overnight Burn .....            | 27 |
| Normal Operating Sounds.....    | 27 |
| Hints for Burning .....         | 28 |
| Selecting Wood.....             | 28 |
| Troubleshooting.....            | 29 |

## **Maintaining Your Appliance**

|   |    |
|---|----|
| Daily Maintenance.....                            | 30 |
| Remove Ash .....                                  | 30 |
| Clean The Glass .....                             | 30 |
| Monthly Maintenance .....                         | 31 |
| Door and Glass Inspection .....                   | 32 |
| Check For Creosote Buildup.....                   | 31 |
| Yearly Maintenance .....                          | 32 |
| Touch Up Paint.....                               | 32 |
| Blower Cleaning.....                              | 32 |
| Firebrick and Baffle Inspection .....             | 32 |
| Door Parts .....                                  | 33 |
| Replacing the Glass.....                          | 33 |
| Replacing the Door Gasket.....                    | 33 |
| Replacing the Door Handle.....                    | 33 |
| Firebox Parts.....                                | 34 |
| Floor & Side Firebrick Removal & Replacement..... | 34 |
| Baffle Removal and Replacement.....               | 35 |
| Air Tube Removal and Replacement .....            | 35 |

## **Warranty**..... To

## **Listing Information**..... 37

## **Optional Equipment**

|                                    |    |
|------------------------------------|----|
| Door Shell Installation .....      | 38 |
| Stove Legs.....                    | 40 |
| Pedestal.....                      | 41 |
| Rear Blower Installation.....      | 42 |
| Outside Air Boot Installation..... | 43 |
| Surround Panels .....              | 44 |
| Front Blower.....                  | 46 |

## **Index**..... 48

## Safety Precautions

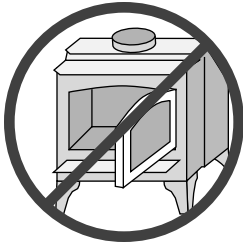

The viewing door must be closed and latched during operation.

Never block free airflow through the air vents on this appliance.



Gasoline or other flammable liquids must never be used to start the fire or "Freshen Up" the fire. Do not store or use gasoline or other flammable liquids in the vicinity of this appliance.



This appliance is designed and approved for the burning of cord wood only. Do not attempt to burn any other type of fuel other than cord wood in this appliance, it will void all warranties and safety listings.



Ashes must be disposed in a metal container with a tight lid and placed on a non-combustible surface well away from the home or structure.



Do not touch the appliance while it is hot and educate all children of the danger of a high-temperature appliance. Young children should be supervised when they are in the same room as the appliance.

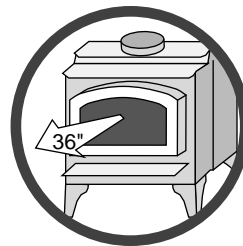

Keep furniture, drapes, curtains, wood, paper, and other combustibles a minimum of 36" away from the front of the appliance.



This appliance must be properly installed to prevent the possibility of a house fire. The instructions must be strictly adhered to. Do not use makeshift methods or compromise in the installation.



Contact your local building officials to obtain a permit and information on any installation restrictions or inspection requirements in your area. Notify your insurance company of this appliance as well.

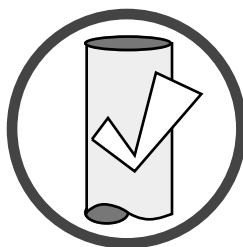

Inspect the chimney connector and chimney at least twice monthly and clean if necessary. Creosote may build up and cause a house fire.

Do not connect this appliance to any chimney serving another appliance.

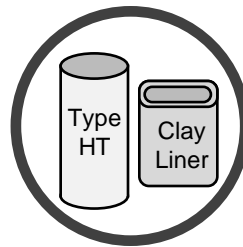

This appliance must be connected to a listed high temperature (UL 103 HT) residential type chimney or an approved masonry chimney with a standard clay tile, or stainless steel liner.



When installed in a mobile home, this appliance must be bolted to the floor, have outside air, and not be installed in the bedroom (Per H.U.D. requirements). Check with local building officials.

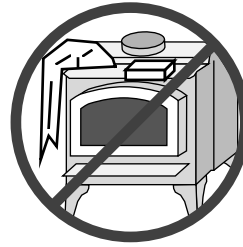

Do not place clothing or other flammable items on or near this appliance.

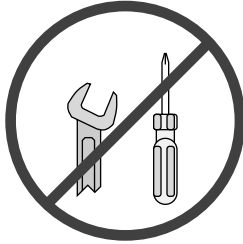

Never try to repair or replace any part of this appliance unless instructions are given in this manual. All other work must be done by a trained technician.

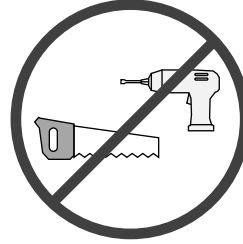

Do not make any changes or modifications to an existing masonry fireplace or chimney to install this appliance.

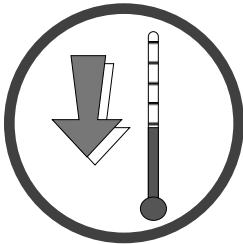

Allow the appliance to cool before carrying out any maintenance or cleaning.

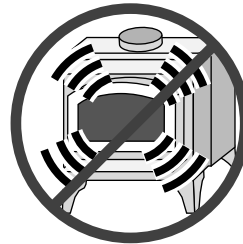

Do not make any changes to the appliance to increase combustion air.

Overfiring the appliance may cause a house fire. If a unit or chimney connector glows, you are overfiring.

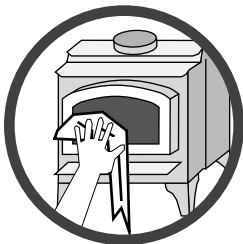

Maintain the door and glass seal and keep them in good condition.

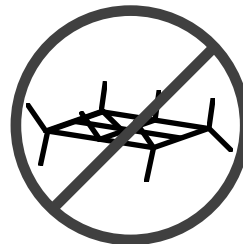

Do not use a grate or other device to elevate the fire off of the firebox floor. Burn the fire directly on the bricks.

Avoid placing wood against the glass when loading. Do not slam the door or strike the glass.

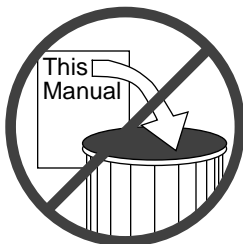

Do not throw this manual away. This manual has important operating and maintenance instructions that you will need at a later time. Always follow the instructions in this manual.



**Travis Industries, Inc. grants no warranty, implied or stated, for the installation or maintenance of your appliance, and assumes no responsibility of any consequential damage(s).**

### Installation Options

- Freestanding
- Freestanding in an Alcove
- Freestanding in a Mobile Home
- Masonry Fireplace Insert
- Zero-Clearance (Metal) Fireplace Insert

### Features

- EPA Phase II Approved
- 1.6 Cubic Foot Firebox Volume
- Single Operating Control
- Accepts Logs Up to 18" Long
- Steel Plate Construction (1/4" & 3/16")
- Heavy Duty Refractory Firebrick
- Optional High-Tech Blower

### Heating Specifications

|  |   |
|--|---|
| Approximate Maximum Heating Capacity (in square feet)* | 750 to 1,400 (stove)<br>750 to 1,200 (insert) |
| Maximum BTU's per Hour (Cord Wood Calculation)         | 66,800  |
| Overall Efficiency (Oregon Method)                     | 70.0 %  |
| Maximum Burn Time                                      | Up to 8 Hours                                 |

\* Heating capacity will vary depending on the home's floor plan, degree of insulation, and the outside temperature. It is also affected by the quality and moisture level of the fuel.

### Dimensions

**Note:**

Measure side, corner, and back clearances from the stove top.

The flue collar protrudes 3/4" above the stove top

**Insert Dimensions:**

Depth into Fireplace\*\* .....13-1/2"  
Onto Hearth\*\*\* .....3"

\* For inserts, add 3/4" for the flue collar.

\*\* ZC (metal) fireplaces require 14-1/2".

\*\*\* Does not include hearth protection.

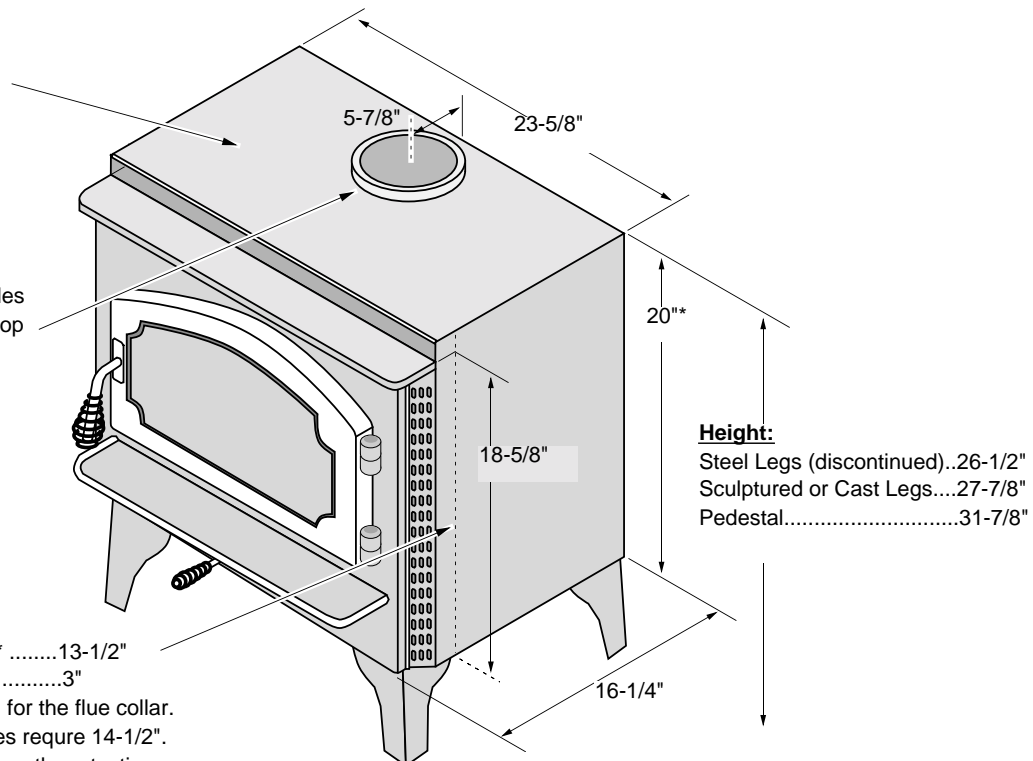

Figure 1

### Emissions

4.4 Grams Per Hour (EPA Phase II Approved) – Tests conducted by E.E.S.P.C.

**SAFETY NOTICE:**

Please read this entire manual before you install and use your new room heater. Failure to follow instructions may result in property damage, bodily injury, or even death. Contact local building or fire officials about restrictions and installation inspection requirements in your area.

**Planning The Installation**



We suggest that you have an authorized Travis Industries dealer install your stove. If you install the stove yourself, your authorized dealer should review your installation plans.



Check with local building officials for any permits required for installation of this stove and notify your insurance company before proceeding with installation.

**Preparation for Installation**

- Check for damage to the exterior of the stove (dents should be reported, scratches can be fixed by applying touch up paint).
- Check the interior of the firebox (replace cracked firebrick and make sure baffle is in place).



The stove can be lightened by removing the firebricks and baffle (pg 34) - replace before operation.

**Additional Accessories Needed for Installation**

- Door Shell (Black 99300195 Brass 99300196 or Pewter 99300197 - see pg 38)
- Legs or Pedestal

**Stove Installation Considerations**

The table below details the six most common types of installations and the considerations for each type. Alternative methods of installation are available if they comply with local building codes.

| <b>Installation Type</b>                                 | <b>Considerations</b>  |
|--|--|
| Standard Ceiling with a Factory Built Chimney (Page 14)  | <ul style="list-style-type: none"> <li>• Requires ceiling and roof penetration</li> <li>• Provides best draft</li> </ul>   |
| Cathedral Ceiling with a Factory Built Chimney (Page 14) | <ul style="list-style-type: none"> <li>• Cathedral style chimney support required</li> <li>• Provides best draft</li> </ul>  |
| Exterior Factory Built Chimney (Page 15)                 | <ul style="list-style-type: none"> <li>• Uses two elbows to route chimney outside</li> <li>• Exterior chimney is hidden from the room</li> <li>• Elbows reduce draft</li> <li>• Optional exterior chase reduces cold air blockage</li> </ul> |
| Hearth Stove Positive Connection (Page 15)               | <ul style="list-style-type: none"> <li>• Utilizes existing masonry or zero clearance (metal) chimney</li> <li>• Provides good draft due to full reline</li> <li>• Easier to clean than direct or horizontal hearth stove</li> </ul>          |
| Hearth Stove Direct Connection (Page 16)                 | <ul style="list-style-type: none"> <li>• Utilizes existing masonry or zero clearance (metal) chimney</li> <li>• Requires construction of a "block-off plate"</li> <li>• Draft reduced due to elbows &amp; chimney cross section</li> </ul>   |
| Interior Masonry Chimney (Page 16)                       | <ul style="list-style-type: none"> <li>• Utilizes existing masonry chimney (not approved for zero clearance (metal) fireplaces)</li> </ul>   |

## Floor Protection Requirements

- Stove must be placed on the Travis Industries legs or Pedestal.
- Floor protection must extend 6" to the sides and rear of the stove and 16" to the front of the stove (35-5/8" wide by 38-1/4" deep - see Figure 2 and Figure 3).
- Floor protection must be non-combustible and at least .018" thick (26 gauge).

## Stove Placement Requirements



Clearances may be reduced by methods specified in NFPA 211, listed wall shields, pipe shields, or other means approved by local building or fire officials.

- Stove must be placed so that no combustibles are within, or can swing within (e.g. drapes, doors), 36" of the front of the stove
- If the stove is placed in a location where the ceiling height is less than 7', it must follow the requirements in the section "Alcove Installation Requirements"
- Must maintain the clearances to combustibles listed below (drywall, furniture, etc.):

## Clearances

- The following clearances must be met (see Figure 2 and Figure 3)

| Minimum Clearance |                         | Singlewall Connector | Reduced Clearance* |
|-------------------|-------------------------|----------------------|--------------------|
| A                 | Sidewall to stove       | 18"                  | 13"                |
| B                 | Backwall to stove       | 16-1/2"              | 9"                 |
| C                 | Cornerwall to stove     | 10"                  | 7-1/2"             |
| D                 | Connector to sidewall   | 27"                  | 21-1/2"            |
| E                 | Connector to backwall   | 19-1/2"              | 11-1/2"            |
| F                 | Connector to cornerwall | 19-1/2"              | 16-1/2"            |

\*Reduced clearance installations require one of the chimneys and connectors listed below:

AMERI-TEC model DCC with model HS chimney  
 DURAVENT model DVL with DURATEC or DURA-PLUS chimney  
 GSW Super Chimney Twenty-One connected directly to appliance  
 I.C.C. Excel (2100-2 Can.) (103-HT USA) chimney with HP connector  
 METALFAB model DW connector with TG chimney  
 OLIVER MACLEOD PROVENT model PV connector with model 3103 chimney  
 SECURITY model DP connector with SECURITY model ASHT or S2100 chimney  
 SELKIRK METALBESTOS model DS connector with model SSII chimney  
 Standard Masonry Chimney with any one of the above listed connectors

**NOTE:** Reduced clearance connectors may not connect to the flue collar – an appliance adapter may be required.

**NOTE:** Standard residential installations with reduced clearance connector may use the clearance determined by the manufacturer of the connector for the connector to wall clearance or the clearance listed in this manual. Offsets must be used to maintain the stove to wall clearance.



## Top View - Straight Installation

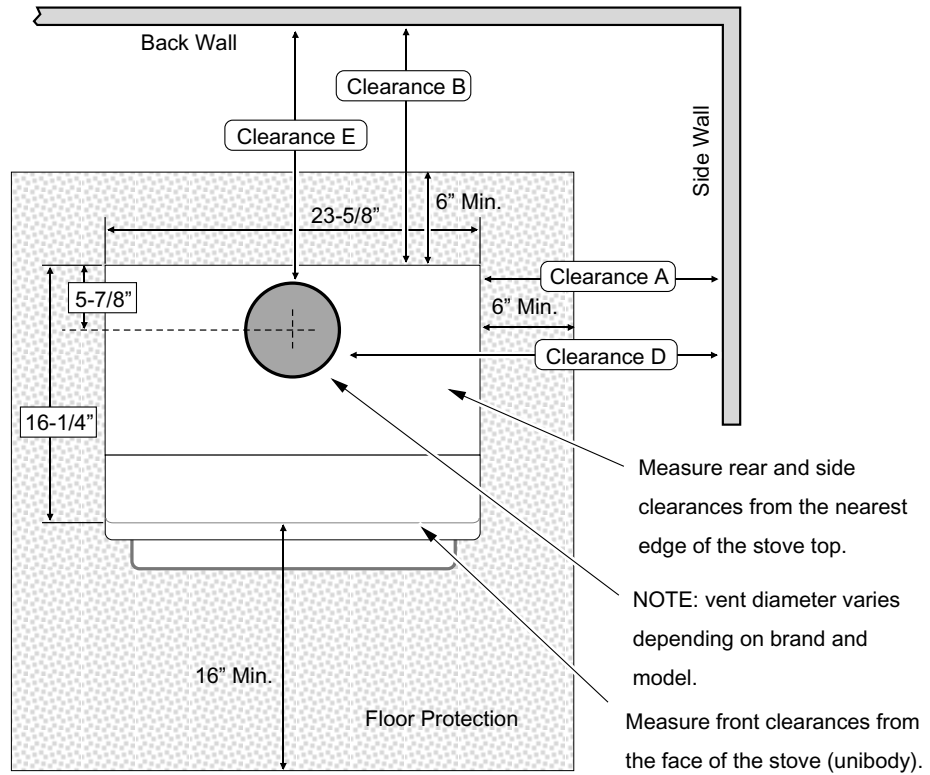

Figure 2

## Top View - Corner Installation

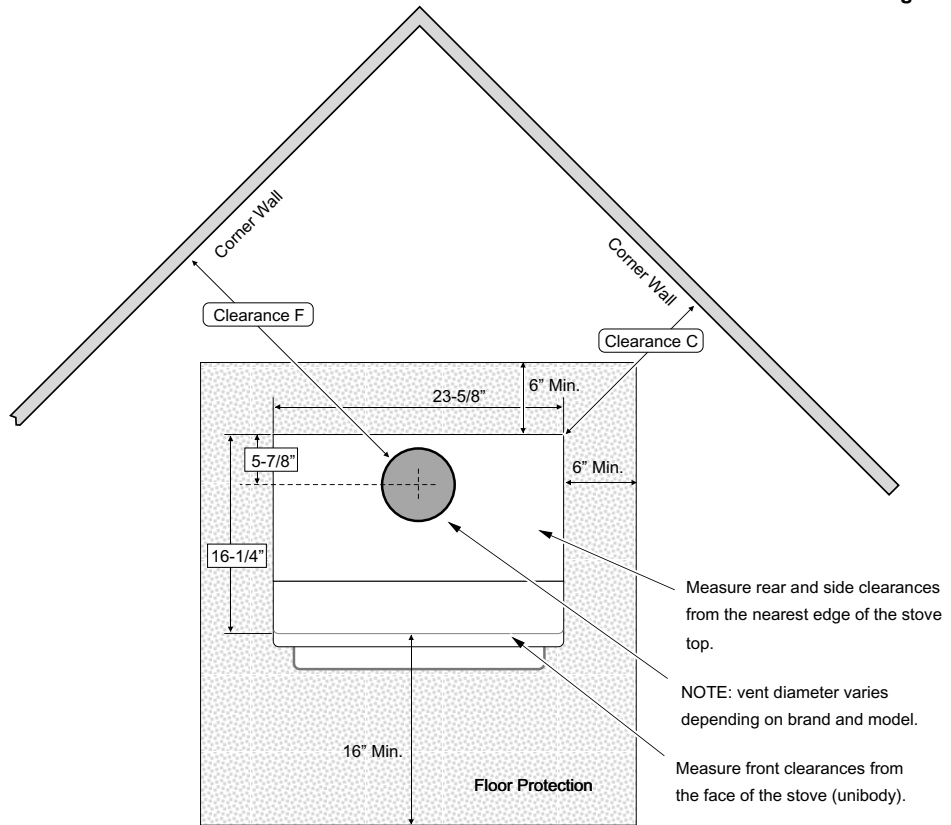

Figure 3





















































































