



- Direct Vent Freestanding Stove
- Natural Gas or Propane
- Vent Horizontally or Vertically
- Standard Residential
- Mobile Home Approved

Featuring the  Burner

Tested and Listed by



WARNING: If the information in these instructions is not followed exactly, a fire or explosion may result causing property damage, personal injury or loss of life.

- Do not store or use gasoline or other flammable vapors and liquids in the vicinity of this or any other appliance.

WHAT TO DO IF YOU SMELL GAS

- Do not try to light any appliance.
- Do not touch any electrical switch; do not use any phone in your building.
- Immediately call gas supplier from a neighbor's phone. Follow the gas supplier's instructions.
- If you cannot reach your gas supplier, call the fire department.
- Installation and service must be performed by a qualified installer, service agency or the gas supplier.

This appliance may be installed in an aftermarket permanently located, manufactured home (USA only) or mobile home, where not prohibited by local codes.

This appliance is only for use with the type(s) of gas indicated on the rating plate. A conversion kit is supplied with the appliance.

WARNING



**HOT GLASS WILL
CAUSE BURNS.
DO NOT TOUCH GLASS
UNTIL COOLED.
NEVER ALLOW CHILDREN
TO TOUCH GLASS.**

Tree of Life GREEN SMART™ Owner's Manual

Installer: After installation give this manual to the home-owner and explain operation of this heater.

© Copyright 2011, T.I. \$10.00 100-01224_000 4110112



**TRAVIS INDUSTRIES
HOUSE OF FIRE**

www.travisproducts.com
4800 Harbour Pointe Blvd. SW
Mukilteo, WA 98275

Introduction

We welcome you as a new owner of an Avalon Tree of Life stove. In purchasing a Tree of Life you have joined the growing ranks of concerned individuals whose selection of an energy system reflects both a concern for the environment and aesthetics. The Tree of Life is one of the finest home heaters the world over. This manual will explain the installation, operation, and maintenance of this stove. Please familiarize yourself with the Owner's Manual before operating your heater and save the manual for future reference. Included are helpful hints and suggestions that will make the operation and maintenance of your new stove an easier and more enjoyable experience. We offer our continual support and guidance to help you achieve the maximum benefit and enjoyment from your heater.

Important Information

No other Tree of Life Stove has the same serial number as yours. The serial number is on the listing plate chained to the gas control valve.

This serial number will be needed in case you require service of any type.

Model: Avalon Tree of Life GS

Serial Number: _____

Purchase Date: _____

Purchased From: _____

Mail your Warranty Card Today, and Save Your Bill of Sale.

To receive full warranty coverage, you will need to show evidence of the date you purchased your heater. Do not mail your Bill of Sale to us.

We suggest that you attach your Bill of Sale to this page so that you will have all the information you need in one place should the need for service or information occur.

Listing Details

This appliance was listed by Intertek to ANSI Z21.88. The listing label is attached to the appliance near the gas control valve.

IAS (ICBO) Approval

This appliance was listed by Intertek Test Labs, an IAS recognized lab.

Massachusetts Approval

This manual has been submitted to the Massachusetts Board of State Examiners of Plumbers and Gas Fitters

National Fireplace Institute



We suggest that our gas hearth products be installed and serviced by professionals who are certified in the U.S. by the National Fireplace Institute® (NFI) as NFI Gas Specialists.

Introduction

Introduction & Important Information 2

Safety Precautions

Safety Precautions 4

Features & Specifications

Features 6
 Installation Options 6
 Heating Specifications 6
 Dimensions 6

Installation

Installation Warning 7
 Packing List 7
 Additional Items Required for Installation 7
 Installation Overview 7
 Installation Hints 8
 Stove Clearances 8
 Mobile Home Requirements 8
 Heater Placement Requirements 9
 Floor Protection Requirements 9
 Electrical Requirements 9
 Optional Wall Switch or Thermostat Installation .. 10
 Gas Line Installation 11
 Vent Requirements 12
 Approved Vent Configurations 13
 Restrictor Position 13
 Measuring Vent Lengths 13
 Vertical Term. with 0, 2, or 4 45° Elbows 14
 Hor. Term. with 1 90° Elbow 15
 Hor. Term. with 2 Elbows 16
 Hor. Term. with 3 Elbows 17
 Vertical Term. with 2 90° Elbows 18
 Vertical Term. with 3 Elbows 19
 Vent Termination Requirements 20
 Class A Chimney Conversion 21
 Interior Masonry Chimney Conversion 22

Finalizing the Installation

Leak Test 23
 Pilot Adjustment (if necessary) 23
 Air Shutter Adjustment (if necessary) 24
 Check Flame 24
 Face and Glass Removal 25
 Log Installation 27

Operation

Before You Begin 31
 Location of Controls 31
 Starting the Stove for the First Time 32
 Turning the Stove On and Off 32
 Comfort Control 32
 Adjusting the Flame Height 32
 Accent Light 33
 Adjusting the Optional Blower Speed 33
 Continuous Pilot / GreenSmart™ Pilot Switch 33
 Normal Operating Sounds 34
 Normal Operating Odors 34

Maintenance

Maintaining Your Stove's Appearance 35
 Battery Replacement 35
 Accent Light Replacement 36
 Yearly Service Procedure 36
 Troubleshooting Table 37
 Wiring Diagram 38
 Replacement Parts List 38

Safety Label

Safety Label 39

Warranty

Warranty 40

Optional Equipment

LP Conversion Kit 41
 GreenSmart™ Remote Control Installation 44

Index

Index 56

Safety Precautions

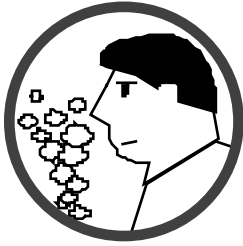

• IF YOU SMELL GAS:

- * Do not light any appliance
- * Extinguish any open flame
- * Do not touch any electrical switch or plug or unplug anything
- * Open windows and vacate building
- * Call gas supplier from neighbor's house, if not reached, call fire department



- This unit must be installed by a qualified installer to prevent the possibility of an explosion. Your dealer will know the requirements in your area and can inform you of those people considered qualified. The room heater should be inspected before use and at least annually by a qualified service person. More frequent cleaning may be required due to excessive lint from carpeting, bedding material, etc.
- The instructions in this manual must be strictly adhered to. Do not use makeshift methods or compromise in the installation. Improper installation will void the warranty and safety listing.

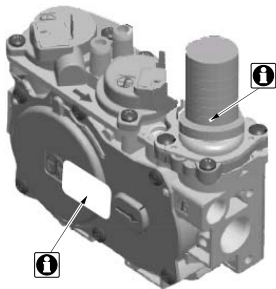

This heater is either approved for natural gas (NG) or for propane (LP). Burning the incorrect fuel will void the warranty and safety listing and may cause an extreme safety hazard. Direct questions about the type of fuel used to your dealer. Check for a label on the flame adjust knob on the gas control valve (this is the best place to check). You may also check for a label on the gas control valve body.



- Contact your local building officials to obtain a permit and information on any installation restrictions or inspection requirements in your area. Notify your insurance company of this heater as well.



- If the flame becomes sooty, dark orange in color, or extremely tall, do not operate the heater. Call your dealer and arrange for proper servicing.



- It is imperative that control compartments, screens, or circulating air passageways of the heater be kept clean and free of obstructions. These areas provide the air necessary for safe operation.



- Do not operate the heater if it is not operating properly in any fashion or if you are uncertain. Call your dealer for a full explanation of your heater and what to expect.



- Do not store or use gasoline or other flammable liquids in the vicinity of this heater.

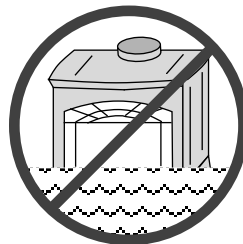

- Do not use this appliance if any part has been under water. Immediately call a qualified service technician to inspect the appliance and to replace any part of the control system and any gas control which has been under water.



- Do not place clothing or other flammable items on or near the heater. Because this heater can be controlled by a thermostat there is a possibility of the heater turning on and igniting any items placed on or near it.

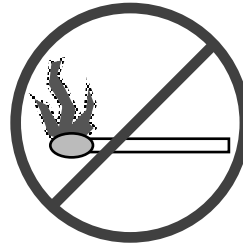

- Light the heater using the built-in igniter. Do not use matches or any other external device to light your heater.
- Allow the heater to cool before carrying out any maintenance or cleaning.



- The viewing glass should be opened only for lighting the pilot or conducting service.
- Any safety screen or guard removed for servicing must be replaced prior to operating the heater.
- Do not operate with the glass removed or damaged.

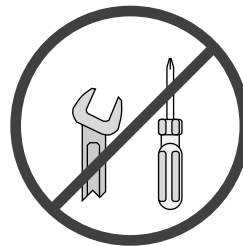

- Never remove, replace, modify or substitute any part of the heater unless instructions are given in this manual. All other work must be done by a trained technician. Don't modify or replace orifices.



- Operate the heater according to the instructions included in this manual.
- If the main burners do not start correctly turn the gas off at the gas control valve and call your dealer for service.

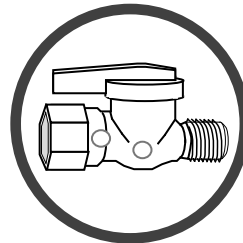

- Instruct everyone in the house how to shut gas off to the appliance and at the gas main shutoff valve. The gas main shutoff valve is usually next to the gas meter or propane tank and requires a wrench to shut off.



- This unit is not for use with solid fuel
- Do not place anything inside the firebox (except the included fiber logs).
- If the fiber logs become damaged, replace with Travis Industries log set.



- Do not throw this manual away. This manual has important operating and maintenance instructions that you will need at a later time. Always follow the instructions in this manual.



- **Travis Industries, Inc. grants no warranty, implied or stated, for the installation or maintenance of your heater, and assumes no responsibility of any consequential damage(s).**

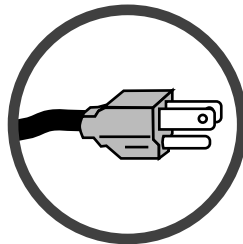

- Plug the heater into a 120V grounded electrical outlet. Do not remove the grounding plug.
- Don't route the electrical cord in front of, over, or under the heater



- Young children should be carefully supervised when they are in the same room as the appliance. Toddlers, young children and others may be susceptible to accidental contact burns. A physical barrier is recommended if there are at risk individuals in the house. To restrict access to a fireplace or stove, install an adjustable safety gate to keep toddlers, young children and other at risk individuals out of the room and away from hot surfaces.

Features:

- Ember Fyre™ Burner for "Wood Fire" Look
- Works During Power Outages (battery backup system)
- High Efficiency
- Optional Thermostat or Remote Control
- Optional Blower for Quicker Heat Distribution
- Convenient Operating Controls
- Variable-Rate Heat Output
- Accent Light

Installation Options:

- Freestanding Stove
- Horizontal or Vertical Vent
- Residential or Mobile Home
- Straight or Corner Placement
- Bedroom Approved

Heating Specifications:

Approximate Heating Capacity (in square feet)* 500 - 1,500 with Blower, 500 to 1,200 Without
 Maximum Input 31,000

- Heating capacity will vary depending on the home's floor plan, degree of insulation, and the outside temperature.

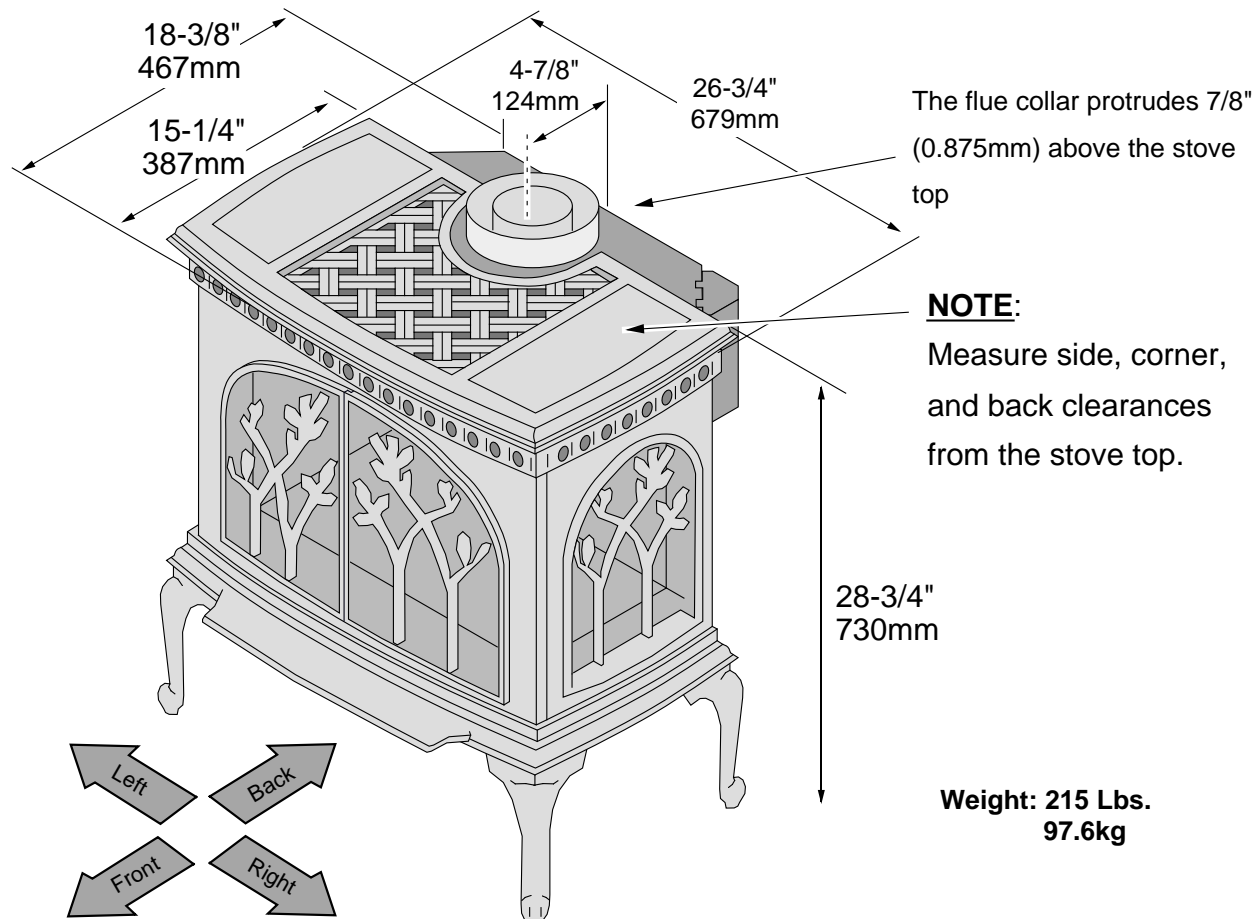
Dimensions & Weight:**Electrical Specifications (for optional blower)**

Electrical Rating 115 Volts, 1.5 Amps, 60 Hz (180 watt)

Fuel:

This heater is shipped in natural gas (NG) configuration but may be converted to propane (LP) using the included LP conversion kit. The sticker on top of the gas control valve will verify the correct fuel.

Installation Warnings:

- ! Failure to follow all of the requirements may result in property damage, bodily injury, or even death.
- ! This heater must be installed by a qualified installer who has gone through a training program for the installation of direct vent gas appliances.
- ! This appliance must be installed in accordance with all local codes, if any; if not, in U.S.A. follow ANSI Z223.1 and NFPA 54(88), in Canada follow CSA B149.1.
- ! In Manufactured or Mobile Homes must conform with: In USA, Manufactured Home Construction and Safety Standard, Title 24 CFR, Part 3280; In Canada, CSA Z240.4 and Gas-Equipped Recreational Vehicles and Mobile Housing. This appliance may be installed in Manufactured Housing only after the home is site located.
- ! This stove is designed to operate on natural gas or propane (LP).
- ! All exhaust gases must be vented outside the structure of the living-area. Combustion air is drawn from outside the living-area structure.
- ! Notify your insurance company before hooking up this stove.
- ! The requirements listed below are divided into sections. All requirements must be met simultaneously. The order of installation is not rigid – the qualified installer should follow the procedure best suited for the installation.

Packing List

- Propane Conversion Kit
- Log Set
- Touch-Up Paint

Additional Items Required

- Vent (see "Venting Requirements" for details)
- Gas Line Equipment (shutoff valve, pipe, etc.)

Installation Overview

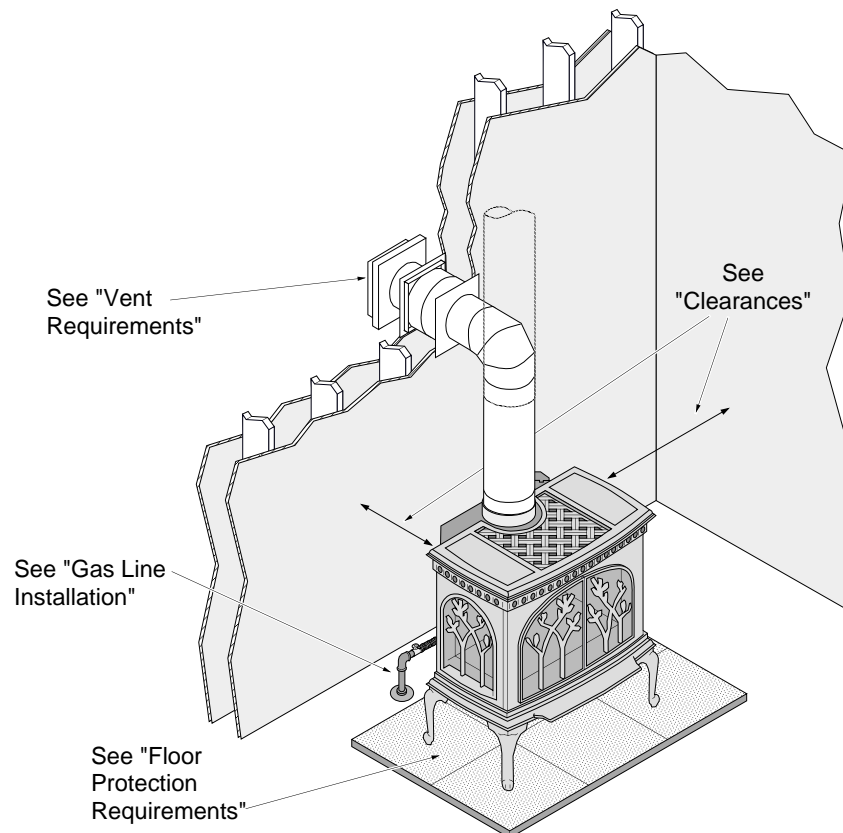



Installation Hints:

- If converting to LP, convert the appliance prior to installation.
- Install the logs last - they are fragile.
- When determining the location of the stove, locate the wall studs (for horizontal penetrations) and ceiling trusses (for vertical penetrations). You may wish to adjust the stove position slightly to ensure the vent does not intersect with a framing member.
- Fumes and smoke from the paint curing and oil burning off the steel may occur the first time you start this heater. This is normal. We recommend you open windows to vent the room.

Stove Clearances

Straight Installations

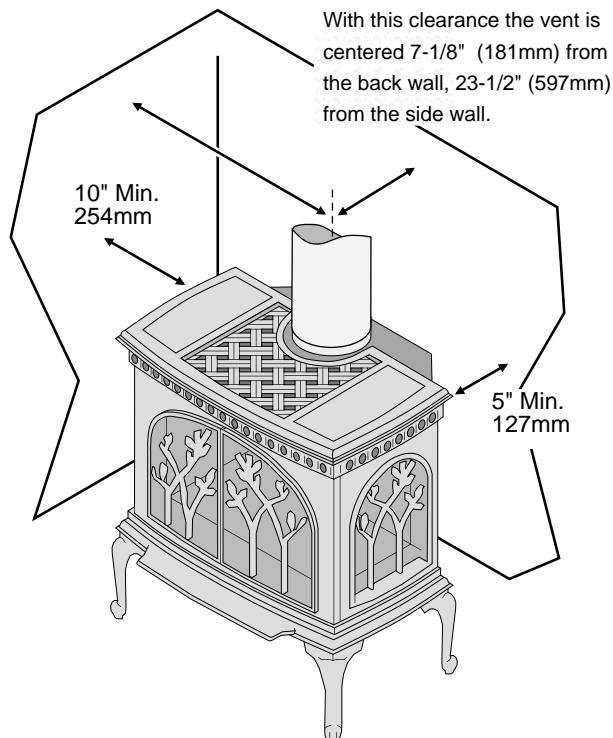

Corner Installations

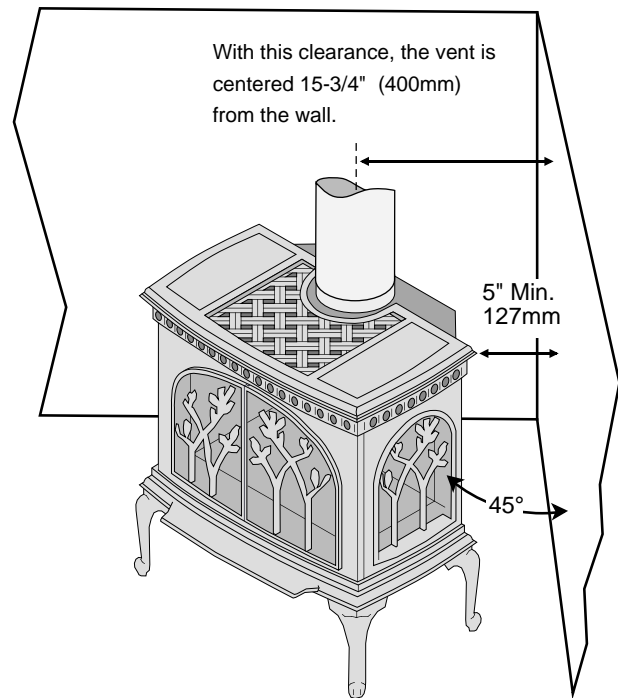

Mobile Home Requirements

- When the stove is installed in a mobile home, it must be bolted to the floor and the appliance grounded (use the optional blower with a grounded circuit or other suitable grounding method - current ANSI/NFPA 70 or CSA C22.1).

Heater Placement Requirements

- Heater must be installed on a level surface capable of supporting the heater and vent
- Due to the high temperature, the heater should be located out of traffic and away from furniture and draperies.
- When placed in a location where the floor to ceiling height is under 7 feet, the installation is considered an alcove and must meet the following requirements:
 - The alcove floor to ceiling height must be at least 58" tall
 - The alcove must not be more than 45" deep before the ceiling returns to 7'
 - The alcove must be at least 46-3/4" wide
- The heater must not be placed so the vents below or above the door, along the sides of heater, or along the back of the heater can become blocked.
- This heater may be placed in a bedroom. Please be aware of the large amount of heat this appliance produces when determining a location.

Floor Protection Requirements

- When the stove is installed directly on carpeting, vinyl or other combustible material other than wood flooring or a high pressure laminate wood floor, the stove must be installed on a metal or wood protection panel extending the full width and depth of the heater (Minimum 26-3/4" wide by 19" deep).

Make sure these rubber tipped bolts on each leg contact the floor (they dampen any noise that may transmit through the hearth). Do not adjust with weight on the legs, the rubber tips may tear.

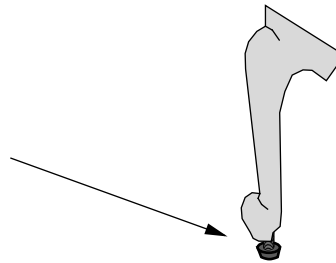

Electrical Requirements

- Plug the stove into a grounded receptacle supplying a minimum 1.5 amps (115 Volts, 60 Hz, 180 watts).
- The appliance, when installed, must be electrically grounded in accordance with local codes or, in the absence of local codes, with the National Electrical Code, ANSI/NFPA 70, or the Canadian Electrical Code, CSA C22.1.

Optional Wall Switch or Thermostat Installation



Do not connect 110-120 VAC to the gas control valve or wiring system of this stove. The switch must be installed by a qualified installer.

This stove may be installed with an optional wall switch or thermostat. The thermostat (or on/off switch) wires will interrupt the burner circuit (see item “a” below).

1. If you wish to bypass the switch, connect the thermostat (on/off switch) wires directly to the green and white wires (see “b” below).
2. If you wish keep the switch (series) – re-align the wires as shown in item “c” below. NOTE: The on/off switch must be in the “ON” position for the thermostat (or on/off switch) to operate.

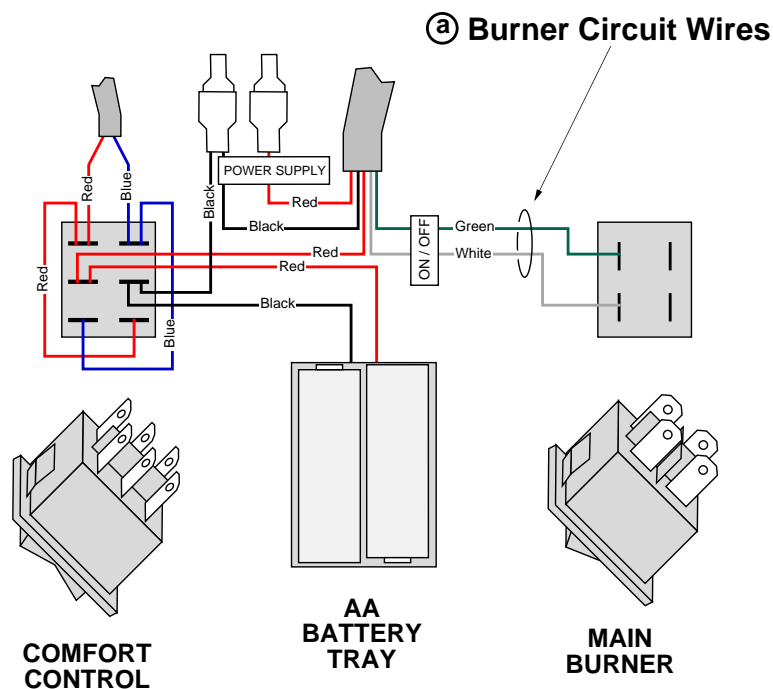

Ⓑ Bypass

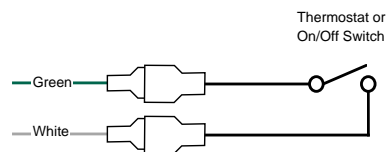

Ⓒ Series

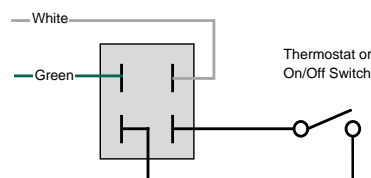

Gas Line Installation

- ! The gas line must be installed in accordance with all local codes, if any; if not, follow current ANSI Z223.1 or NFPA 54 in the USA and the current CSA B149.1 in Canada.
- ! The heater and gas control valve must be disconnected from the gas supply piping during any pressure testing of that system at test pressures in excess of 1/2 psig (3.45 kPa). For pressures under 1/2 psig (3.45 kPa), isolate the gas supply piping by closing the manual shutoff valve.
- This heater is designed for natural gas but can be converted to propane. Check the sticker on top of the gas control valve to verify the correct fuel is used (see page 4).
- Leak test all gas line joints and the gas control valve prior to and after starting the heater.
- The location of the gas inlet is shown below
- A manual shutoff valve is required for installation (it must be located within 3' of the heater). T-Handle gas cocks are required in Massachusetts in compliance with code 248CMR.
- This stove is shipped with a 24" long, 3/8" diameter flex gas line attached to an elbow on the gas control valve (see illustration below for location). The flex accepts a 3/8" flare fitting.

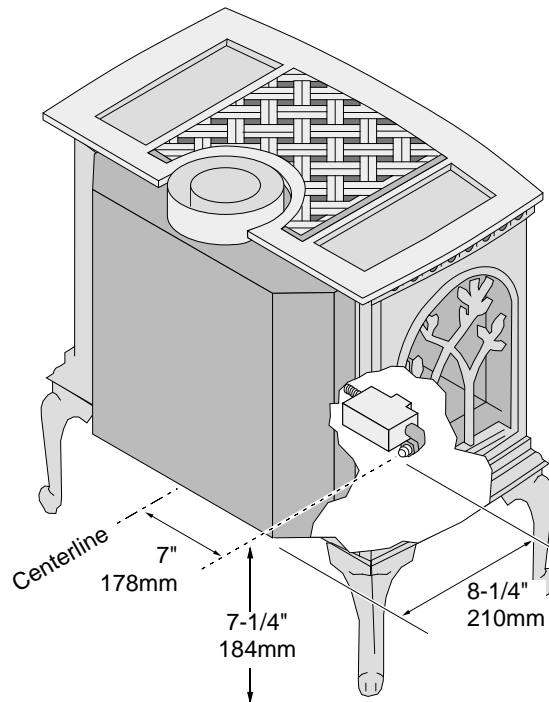

Gas Inlet Pressure

- With the heater off, the inlet pressure must meet the requirements listed in the table below
- If the pressure is not sufficient, make sure the piping used is large enough and the total gas load for the residence does not exceed the amount supplied.
- The supply regulator (the regulator that attaches directly to the residence inlet or to the propane tank) should supply gas at the suggested input pressure listed below. Contact the local gas supplier if the regulator is at an improper pressure.

	Standard Input Pressure
Natural Gas	7" W.C. (1.74 Kpa)
Propane	13" W.C. (3.23 Kpa)

Vent Requirements

- The gas appliance and vent system must be vented directly to the outside of the building, and never be attached to a chimney serving a separate solid fuel or gas-burning appliance. Each direct vent gas appliance must use its own separate vent system.
- In addition to the requirements listed here, follow the requirements provided with the vent.
- When the vent passes through a wall a wall thimble is required. When the vent passes through a ceiling a support box or firestop is required. When the vent passes through the roof, a roof flashing and storm collar are required. Follow the instructions provided with the vent for installing these items. NOTE: Wall thimbles may have different dimensions than what is required by this heater.
- The vent must maintain the required 1" clearance to combustible materials to prevent a fire. Do not fill air spaces with insulation.

Altitude Considerations

- Failure to adjust the air shutter properly may lead to improper combustion which can create a safety hazard. Consult your dealer or installer if you suspect an improperly adjusted air shutter.
- This heater has been tested at altitudes ranging from sea level to 6,000 feet (1,800 M). In this testing we have found that the heater, with its standard orifice, burns correctly with just an air shutter adjustment.

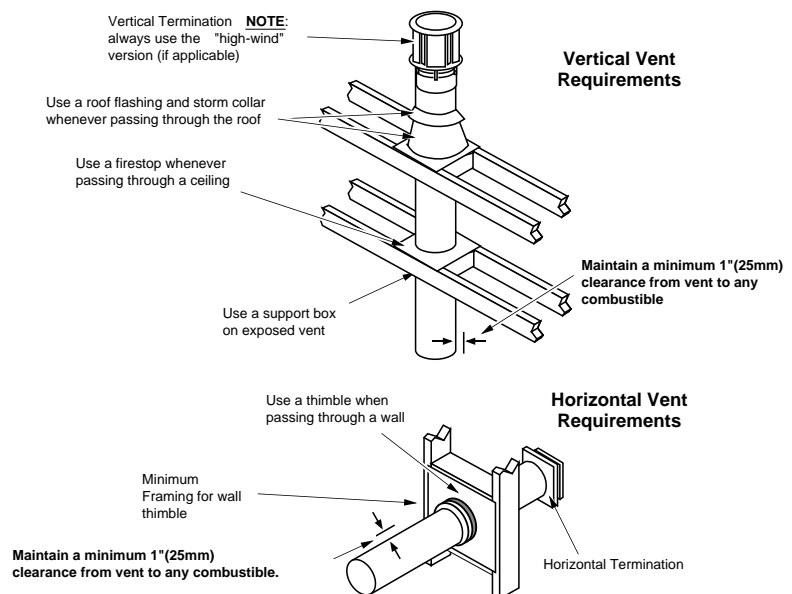

Approved Vent

- Use 6-5/8" (168mm) diameter Simpson Dura-Vent Direct-Vent Pro (or GS)*. * Other vent may be approved with this stove. Check with the vent manufacturer for details.
- Always use the high-wind cap (or high-wind scone cap, part # 46DVA-HSCH).
- Installation instructions for Simpson Dura-Vent may be found at www.duravent.com

Vent Installation

- Slide the vent sections together and turn 1/4 turn until the sections lock in place.
- Screws are not required to secure the vent. However, three screws may be used to secure vent sections together if desired.
- High temperature sealant is recommended at the appliance starter section connection (use high-temperature silicone or Mill-Pac®).
- If disassembly is required, at time of re-assembly check to see if the vent creates a tight fit. If it does not, apply high temperature sealant to the joints of the affected sections.
- Horizontal sections require a 1/4" rise every 12" of travel
- Horizontal sections require non-combustible support every three feet (e.g.: plumbing tape)

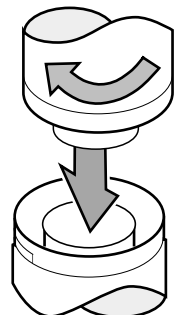

Approved Vent Configurations

Restrictor Position

- A restrictor is built into the appliance to control the flow rate of exhaust gases. This ensures proper flames for the wide variety of vent configurations. Depending upon the vent configuration, you may be required to adjust the restrictor position. The charts for approved vent configurations describe which position the vent restrictor must be in.

To Adjust the Restrictor

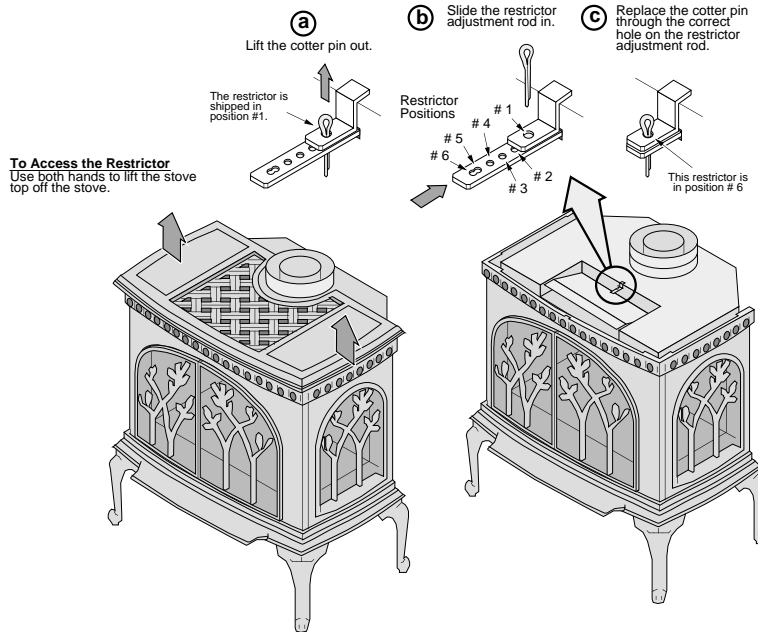

Measuring Vent Lengths

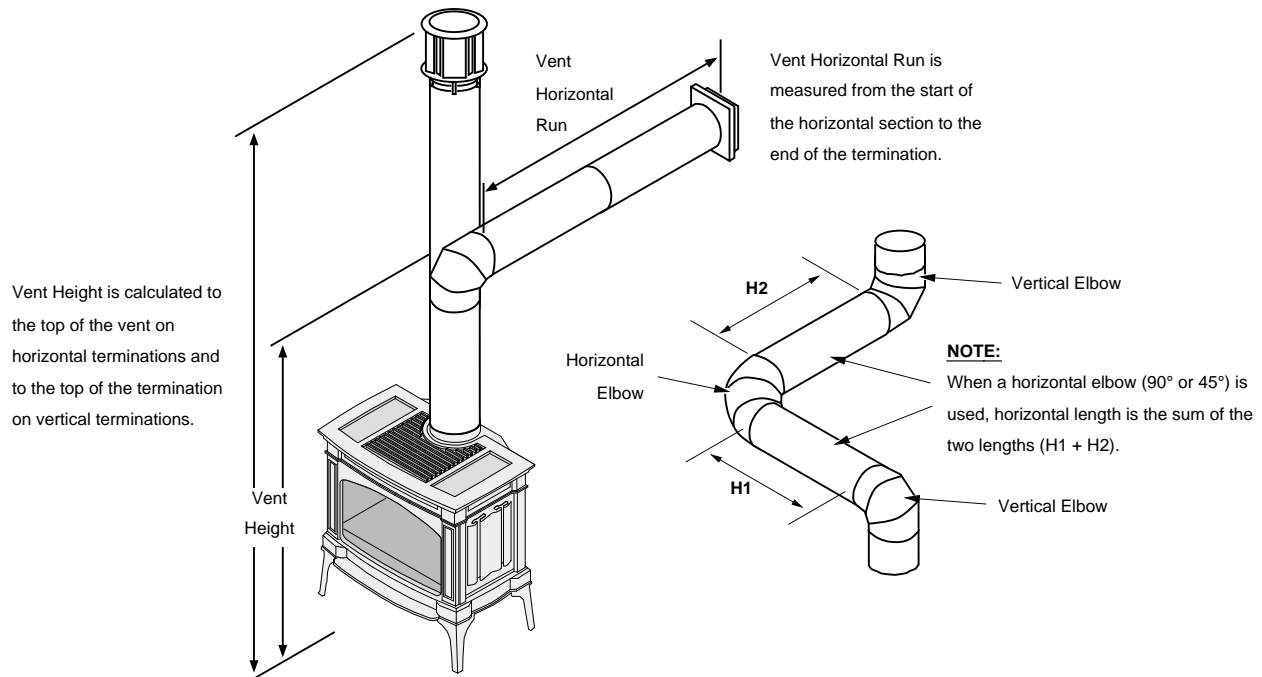

Vertical Terminations with Zero, Two, or Four 45° Elbows

- 10' Minimum System Height (with or without offsets)
- 40' Maximum System Height
- 24' Maximum Offset
- The termination must fall within the shaded area shown in the chart. Use the indicated restrictor position.

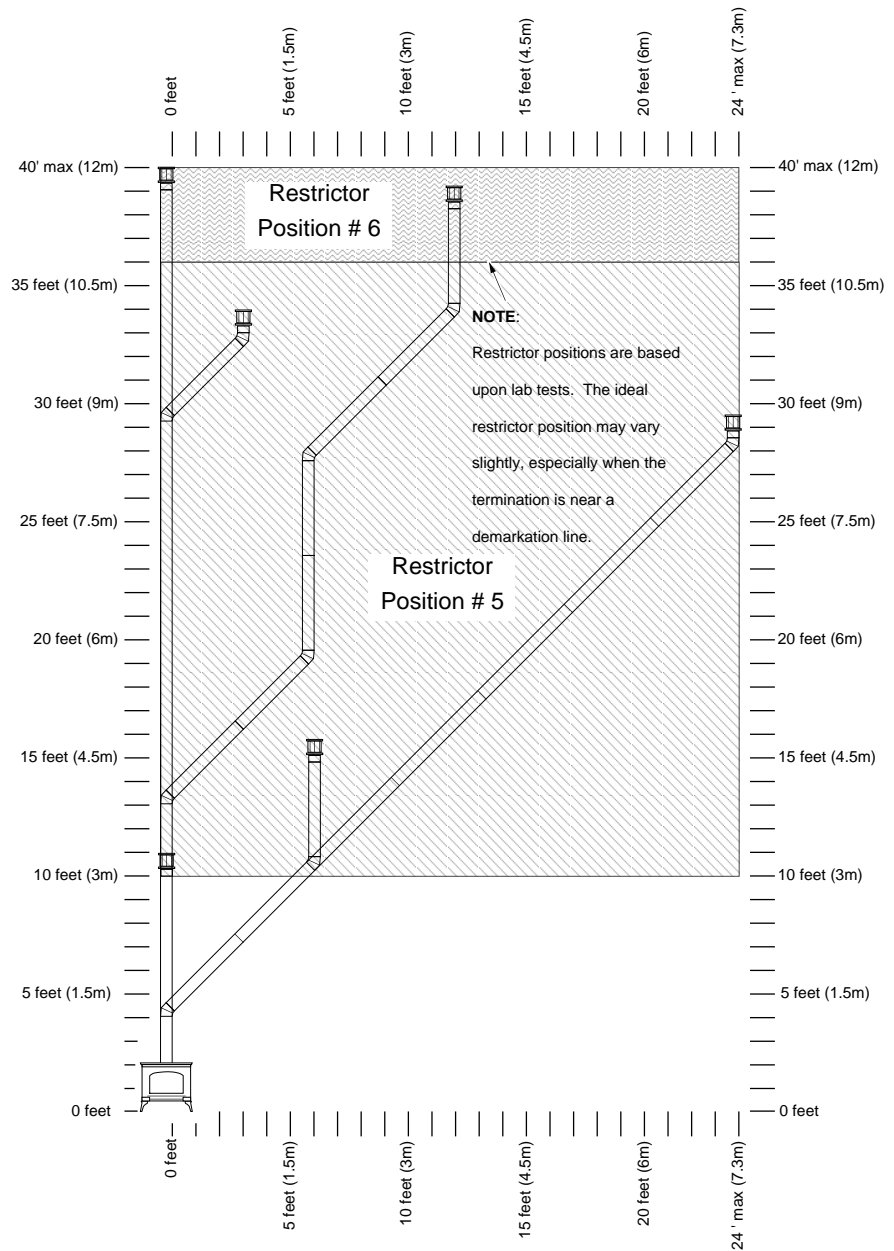

Horizontal Termination with One 90° Elbow

- If using a Snorkel Termination (14" or 36") add the snorkel height to the vertical height (snorkel terminations are used primarily for basement installations).
- The termination must fall within the shaded area shown in the chart. Use the indicated restrictor position.

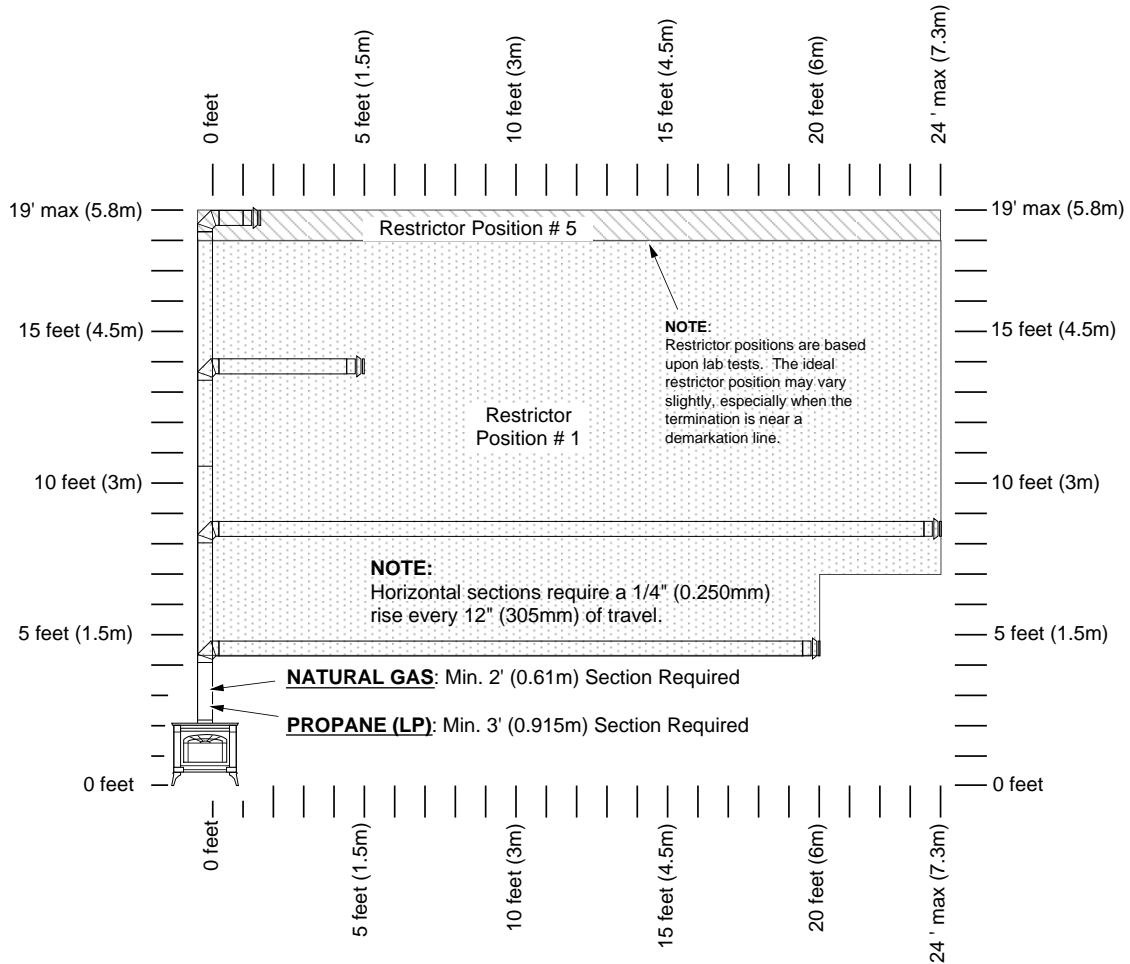

Horizontal Termination with Two Elbows (one 90° vertical and one 90° or 45° horizontal elbow)

- If using a Snorkel Termination (14" or 36") add the snorkel height to the vertical height (snorkel terminations are used primarily for basement installations).
- The termination must fall within the shaded area shown in the chart. Use the indicated restrictor position.

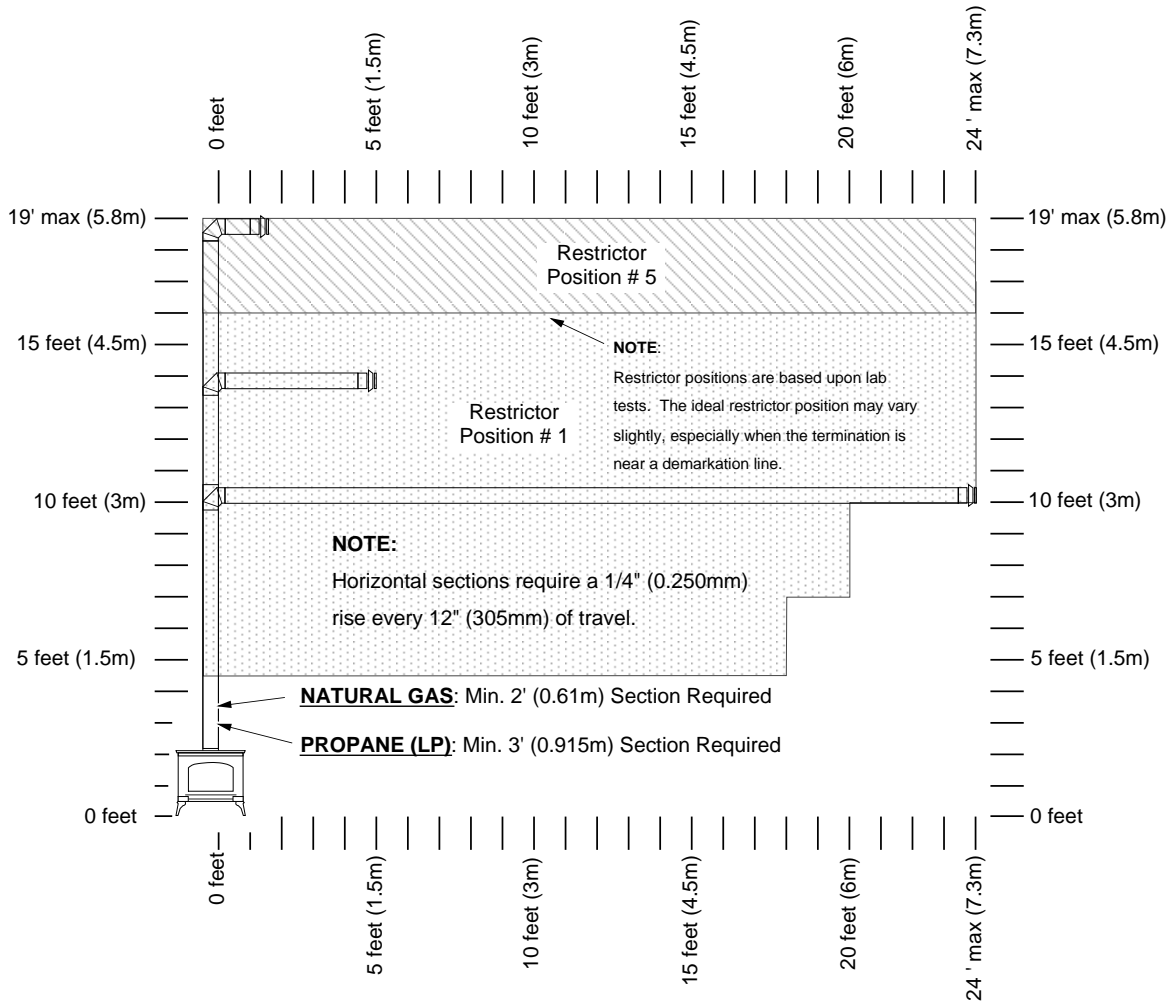

Horizontal Termination with Three 90° Elbows (all vertical)

- If using a Snorkel Termination (14" or 36") add the snorkel height to the vertical height (snorkel terminations are used primarily for basement installations).
- The termination must fall within the shaded area shown in the chart. Use the indicated restrictor position.

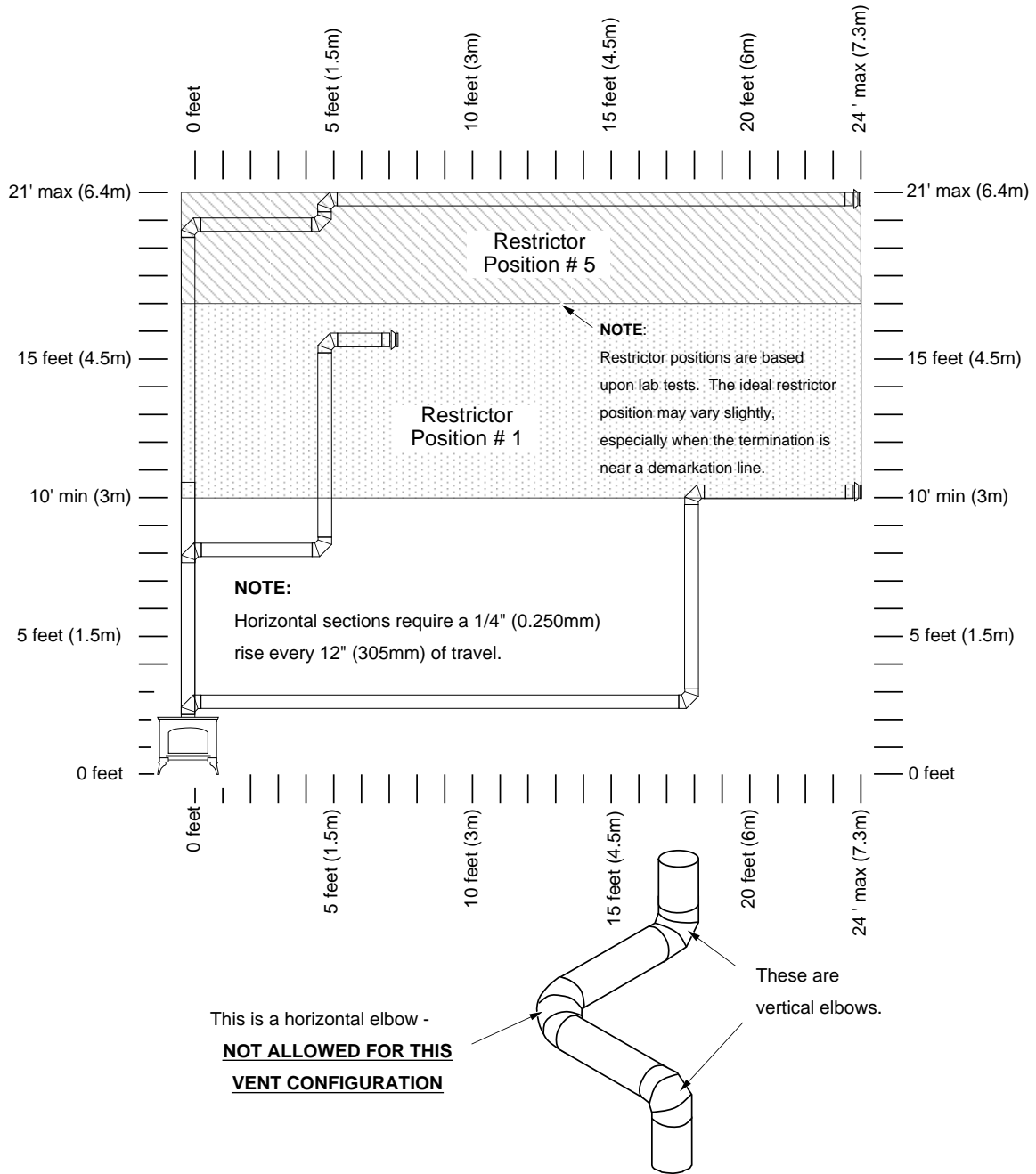

Vertical Terminations with Two 90° Elbows

- The termination must fall within the shaded area shown in the chart. Use the indicated restrictor position.

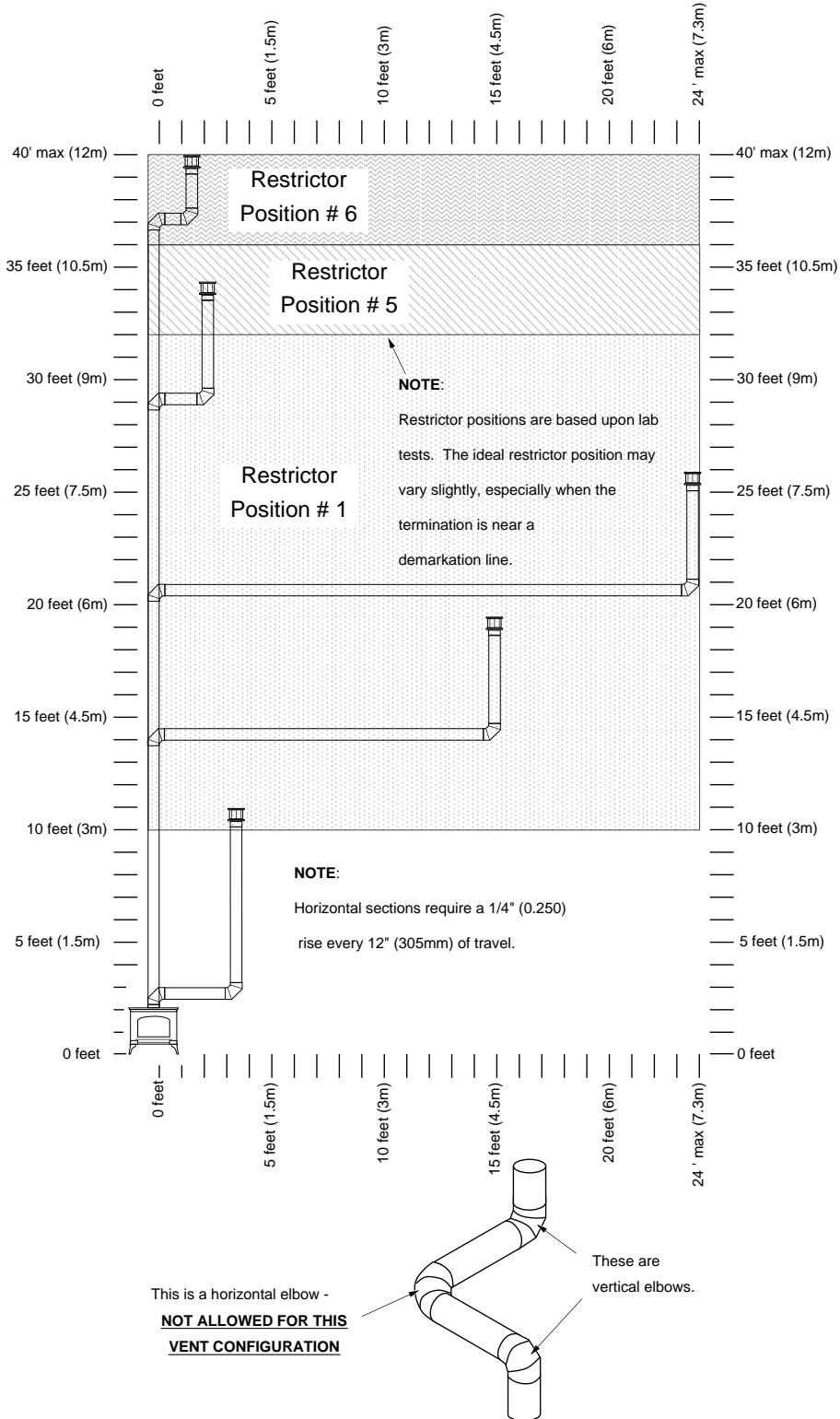

Vertical Terminations with Three 90° Elbows (Two 90° Vertical and One 45° or 90° Horizontal Elbow)

- The termination must fall within the shaded area shown in the chart. Use the indicated restrictor position.

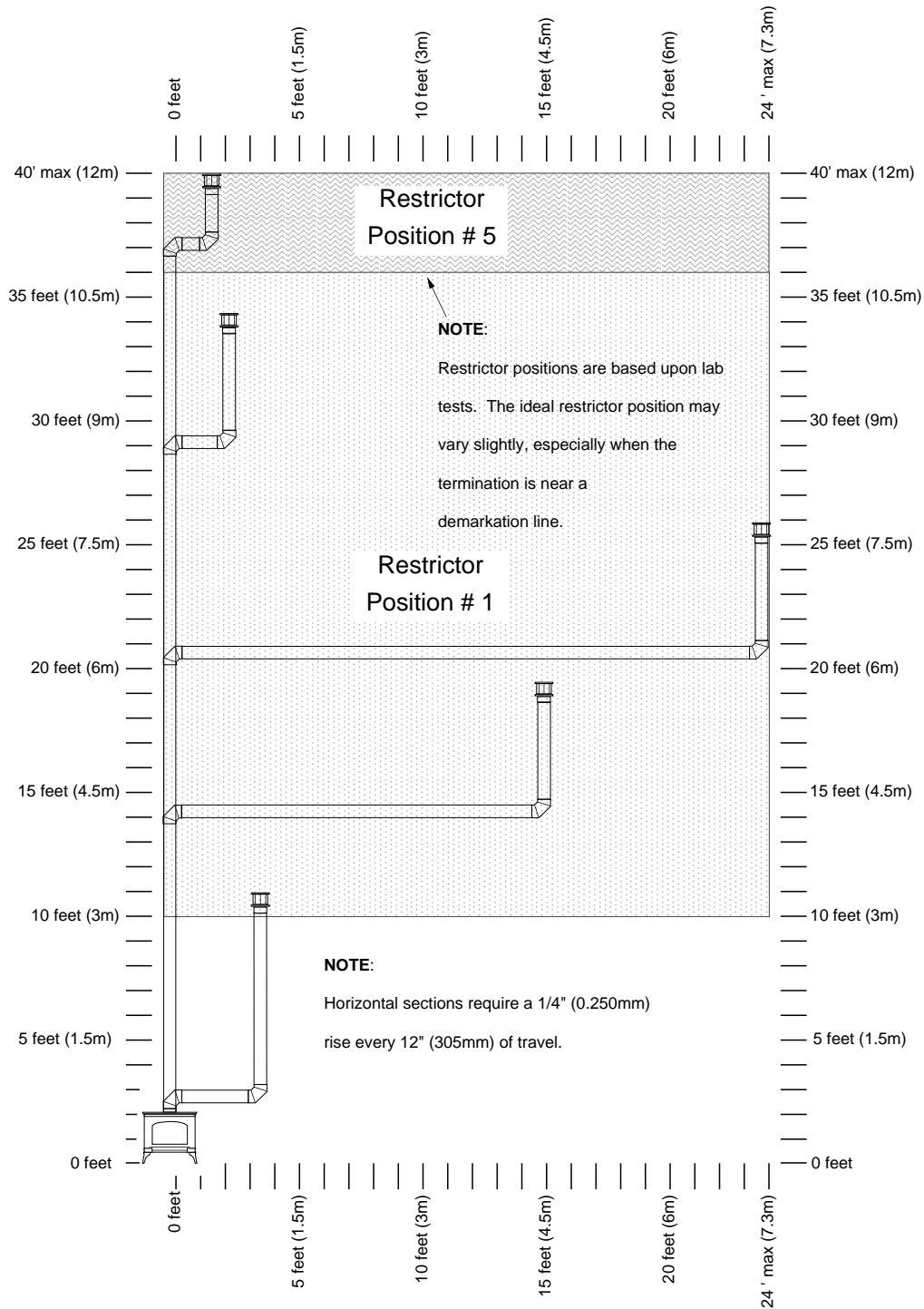

Vent Termination Requirements (see illustration below)

! Venting terminals shall not be recessed into a wall or siding.

- A Minimum 9" (229mm) clearance from any door or window
- B Minimum 12" (305mm) above any grade, veranda, porch, deck or balcony
- C Minimum 12" (25mm) from outside corner walls
NOTE: Clearance in accordance with local installation codes and the requirements of the gas supplier.
- D Minimum 12" (25mm) from inside corner walls
NOTE: Clearance in accordance with local installation codes and the requirements of the gas supplier.
- E Minimum 11" (279mm) clearance below unventilated soffits or roof surfaces
 Minimum 18" (457mm) clearance below ventilated soffits
 Minimum 6" (152mm) clearance below roof eaves
NOTE: Vinyl surfaces require 24" (610mm)
NOTE: Clearance in accordance with local installation codes and the requirements of the gas supplier.
- F Minimum 12" (305mm) clearance below a veranda, porch, deck or balcony
NOTE: Permitted only if veranda, porch, deck, or balcony is fully open on a minimum of two sides beneath the floor.
NOTE: Clearance in accordance with local installation codes and the requirements of the gas supplier.
- G Minimum 48" (1219mm) clearance from any adjacent building
- H Minimum 84" (2134mm) clearance above any grade when adjacent to public walkways or driveways
NOTE: may not be used over a walkway or driveway shared by an adjacent building
- I Minimum 9" (229mm) clearance to any nonmechanical air supply inlet to the building or the combustion air inlet to any other appliance.
- J Minimum 36" (914mm) clearance above any mechanical air supply inlet if within 10' (3M) horizontally
- K Minimum 36" (914mm) from the area above the meter/regulator (vent outlet) - this extends 15' (4.5M) above the regulator
NOTE: Clearance in accordance with local installation codes and the requirements of the gas supplier.
- L Minimum 36" (914mm) from the meter/regulator (vent outlet)
NOTE: Clearance in accordance with local installation codes and the requirements of the gas supplier.
- M Minimum 12" (305mm) above the roof line (for vertical terminations)
- N Minimum 24" (610mm) horizontal clearance to any surface (such as an exterior wall) – for vertical terminations

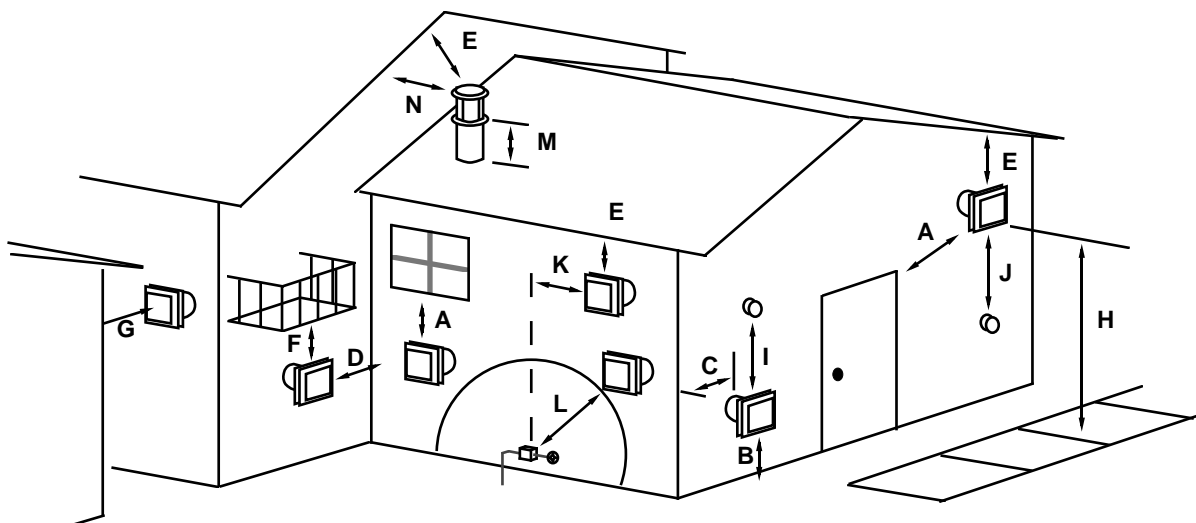
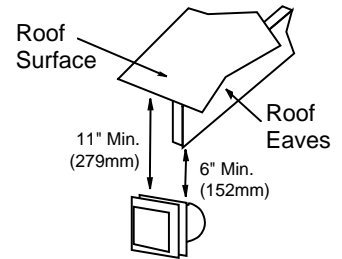

NOTE: Measure clearances to the nearest edge of the exhaust hood.

- Use the vinyl siding standoff when installing on an exterior with vinyl siding.
- Vent termination must not be located where it will become plugged by snow or other material

Class A Chimney Conversion Kit

Simpson DuraVent provides a conversion kit for those wishing to use an existing wood stove chimney to vent this direct vent stove. The illustration below gives an overview of this type of installation. See the instructions included with the kit for details.

- ! Do not exceed the maximum vertical rise (see the section "Approved Vent Configurations" starting on page 13) allowable. Remember to set the restrictor position to the correct position (based upon the vertical rise height - see the chart on page 14).
- ! The conversion kit does not work on interior masonry chimneys.

Chimney Conversion Kit A (# 931)

Metalbestos 6" I.D.
Security Chimneys 6" I.D.
Jacks-Evans 6" I.D.
Hart & Cooley 6" I.D.
Pro-Jet 6" I.D.

Chimney Conversion Kit B (# 932)

Simpson Dura-Vent 6" I.D.
Air-Jet 6" I.D.
Metal-Fab 6" and 7" I.D.
Amer. Metals 6" & 7" I.D.
Metalbestos 7" and 8" I.D.
Jacks-Evans 7" and 8" I.D.
Hart & Cooley 7" and 8" I.D.
Pro-Jet 7" and 8" I.D.
Security Chimneys 8" I.D.

Chimney Conversion Kit C (# 933)

Simpson Dura-Vent 7" and 8" I.D.
American Metals 8" I.D.
Air-Jet 8" I.D.
Metal-Fab 8" I.D.
American Metals 8" I.D.

Each Kit Contains:

Retro Connector
Retro Vertical Top

Additional Required Equipment:

4" Flex (#711 or U.L. 1777)
Termination (#991)
Co-Axial Sections

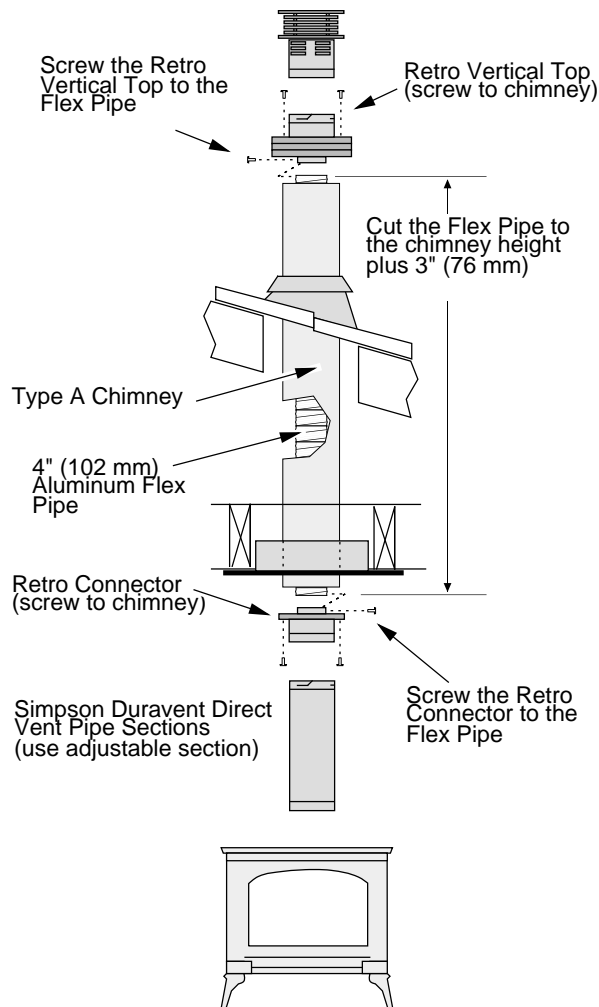

Interior Masonry Chimney Conversions

- Follow the requirements and use the equipment listed in the illustration below to install this appliance into an interior masonry chimney.
- Maximum vertical rise is 40'
- Minimum vertical rise is 10'
- See the chart on page 18 for determining the correct restrictor position.
NOTE: these restrictor positions are based upon lab tests. The ideal restrictor position may vary slightly.

Interior Masonry Chimney

The entire chimney system **must be air-tight**. Make sure to seal the flashing, clean-out, and thimble connection, and to inspect the chimney.

Make sure the coaxial pipe maintains a 1" clearance to any combustible. The vent must be sealed air-tight.

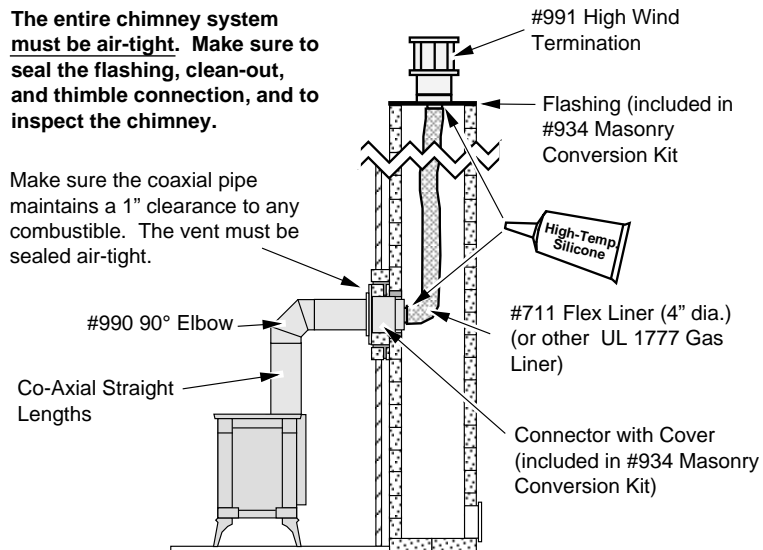

Standard Masonry Fireplace

The entire chimney system **must be air-tight**. Seal the connector cover and inspect the chimney.

Make sure the coaxial pipe maintains a 1" clearance to any combustible. The vent must be sealed air-tight.

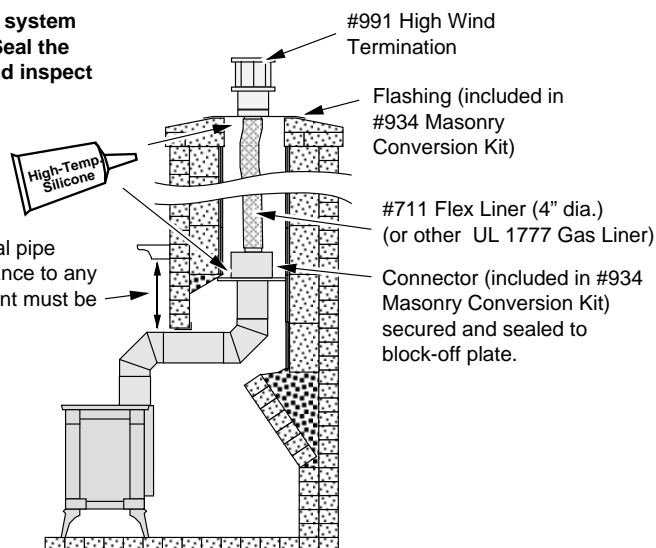

Steps for Finalizing the Installation

1. Remove the glass (see page 25).

NOTE: If using propane (LP) convert the appliance prior to installing the logs.

2. We recommend you purge the gas line at this time (with the glass removed). This allows gas to be detected once it enters the firebox, ensuring gas does not build up.
3. Make sure the accent light bulb is in place.

NOTE: Take care to not touch the bulb with your fingers – use a cloth or paper towel).

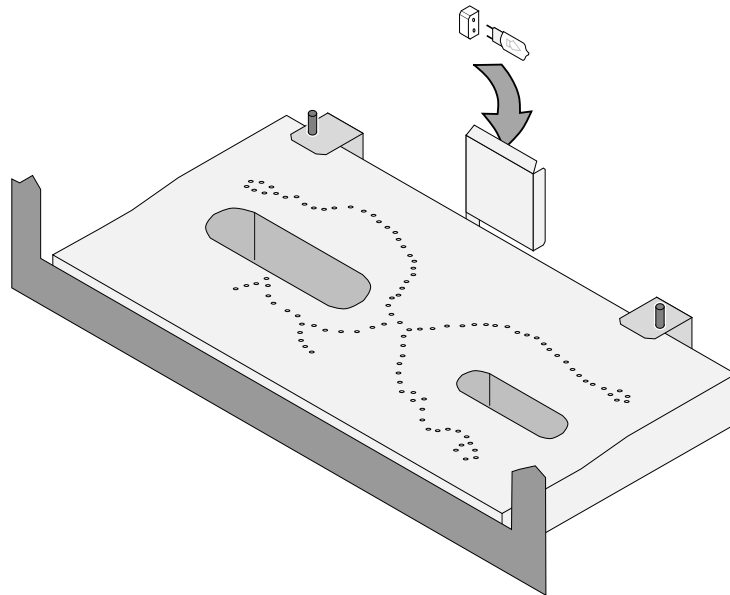

4. Install the four AA batteries (included in the owner's pack) into battery holder (see the illustration below). The AA batteries act as a power backup in case the household (AC) power goes out. Install the 9v battery (included in the owner's pack) into control panel light assembly (see the illustration below). The battery holder is held in place with Velcro and may be removed for easier access.

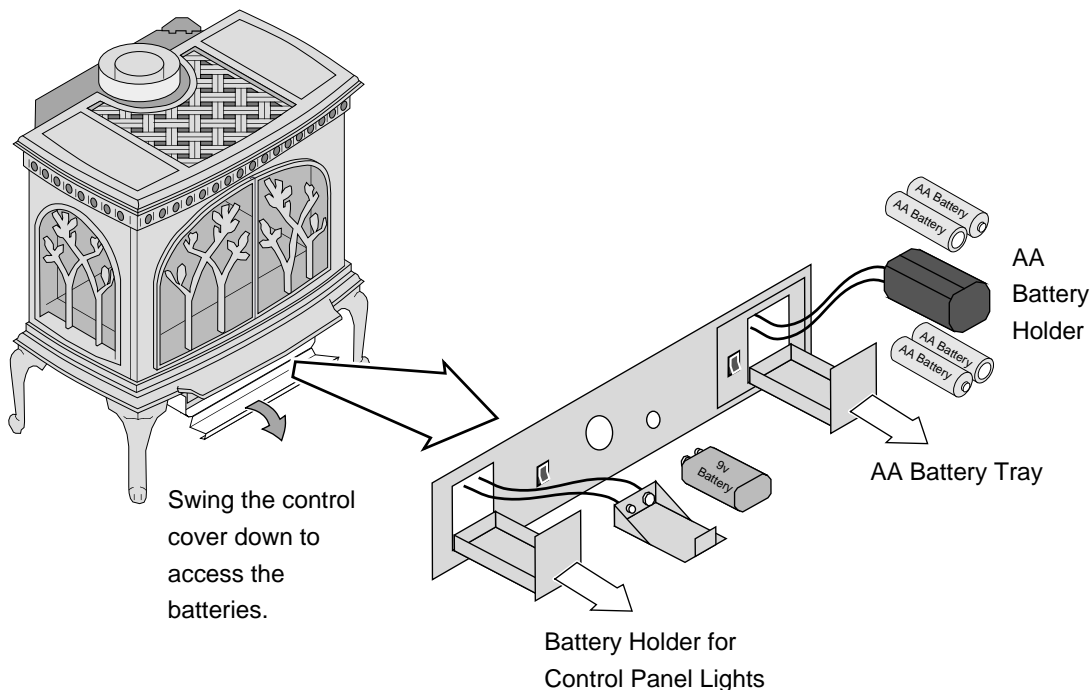

5. Install the logs (see page 27).
6. Replace the glass.
7. Start the heater.
8. Leak test all gas joints.
9. Check the air shutter following the directions below.

Air Shutter Adjustment

Let the heater burn for fifteen minutes (make sure the logs and glass are in place). The flames should be yellow with no sooting. Adjust the air shutter, if necessary, to achieve the correct looking flame.

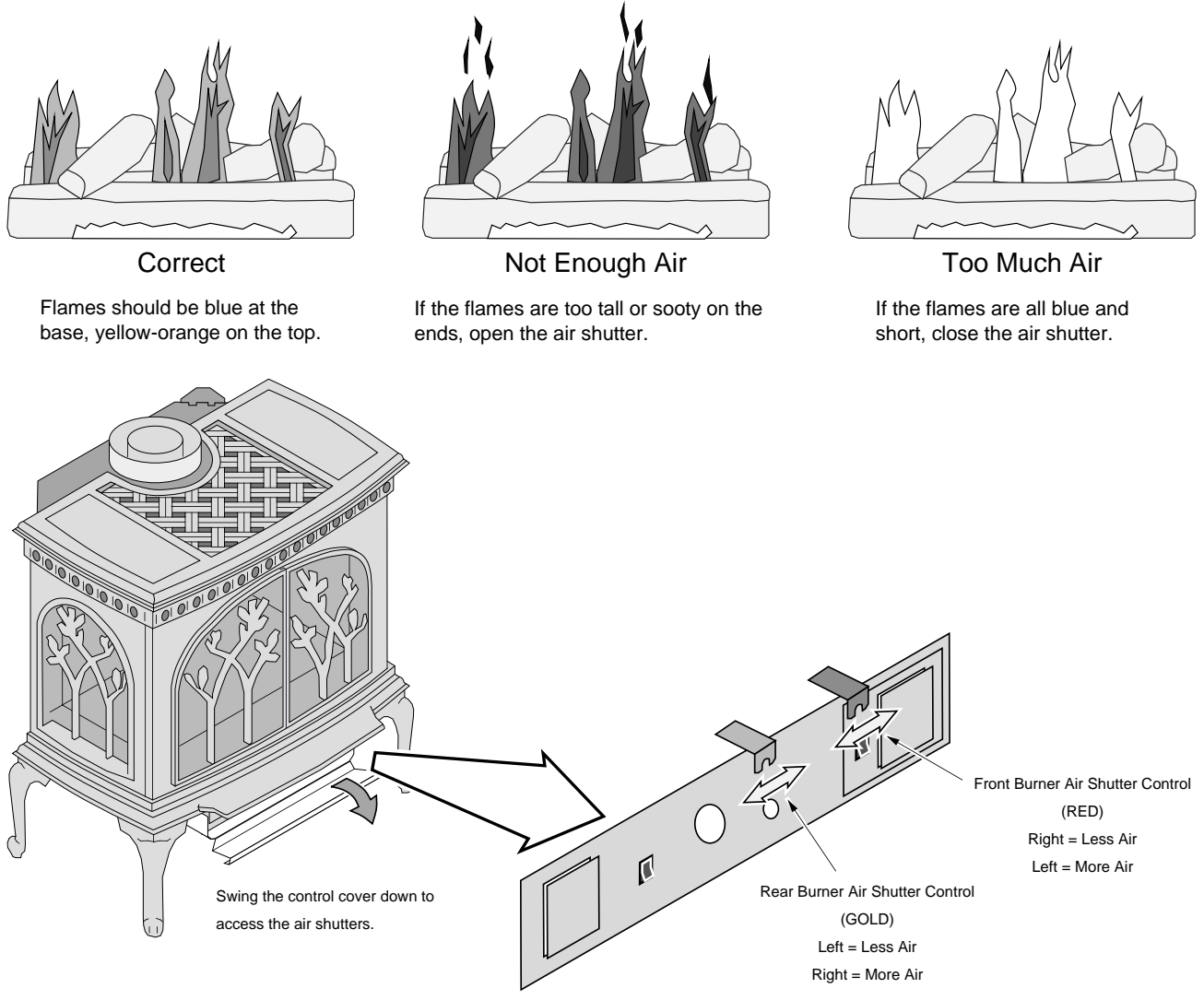

10. Turn the flame adjust knob to its highest position - the flames should not contact the top of the firebox. Check the flame on low position. The flames should burn off of each burner hole. If the heater does not work correctly, contact your Travis dealer for a remedy.
11. Give this manual to the home owner for future reference and fully explain operation of this heater.

Face and Glass Removal

! Make sure the gas control valve is "OFF" and the heater is cool prior to conducting service.

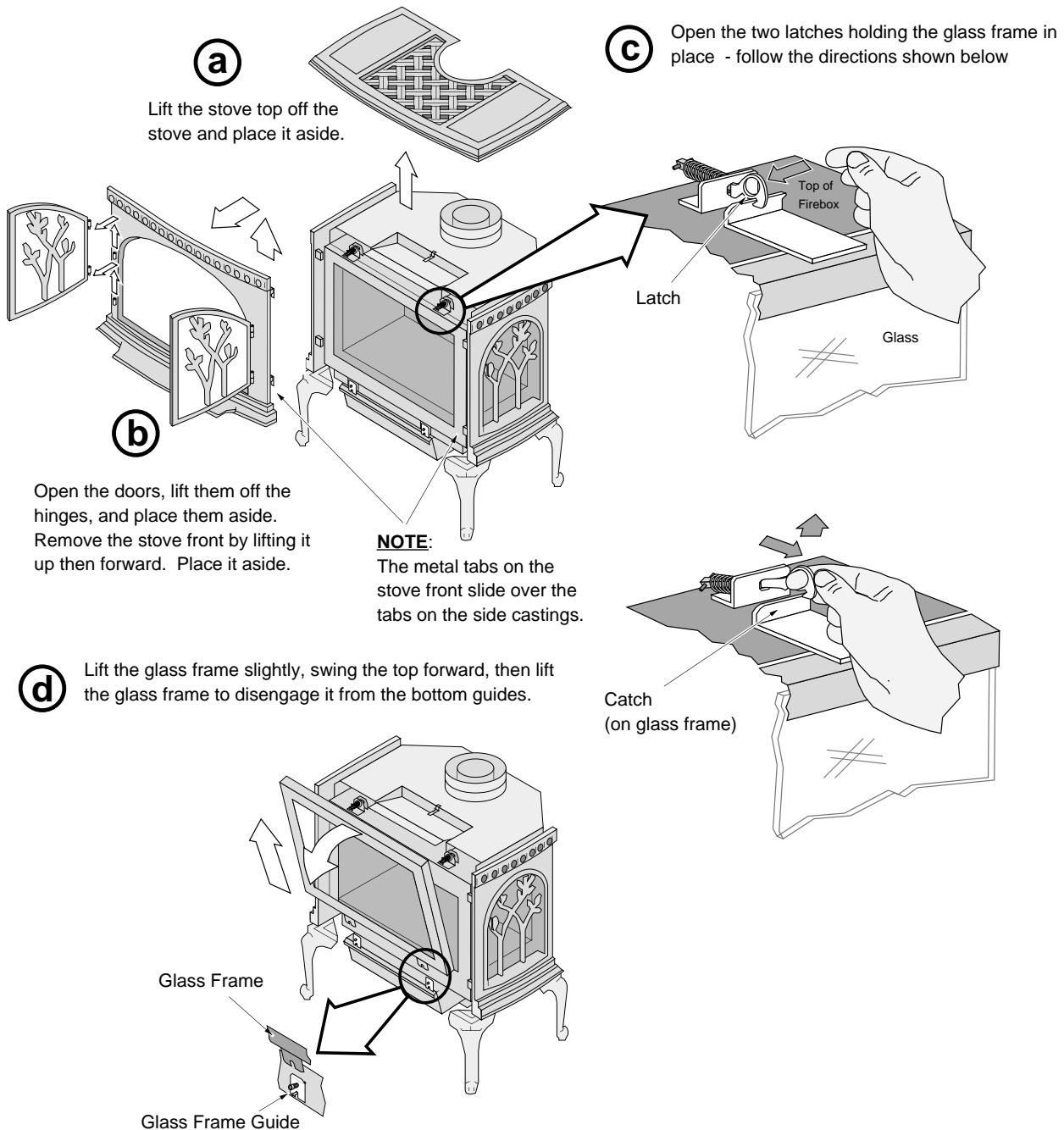

Re-Attaching the Glass Frame:

- Slide the two brackets on the bottom of the glass frame into the glass frame guides (hold the glass frame at a slight angle).
- Swing the glass frame into place - you may have to lift it slightly to allow it to fit over the top of the firebox.
- Attach the upper latches (follow the instructions above in reverse).
- Replace the stove front and top.

Glass Frame Removal and Installation (continued)

The latch can come loose from glass frame anchor. This occurs when it is turned 1/4 turn when it is disengaged. Follow the directions below to re-install the latch if it becomes loose.

Hold the latch at an angle and insert it into the slot on the glass frame anchor.

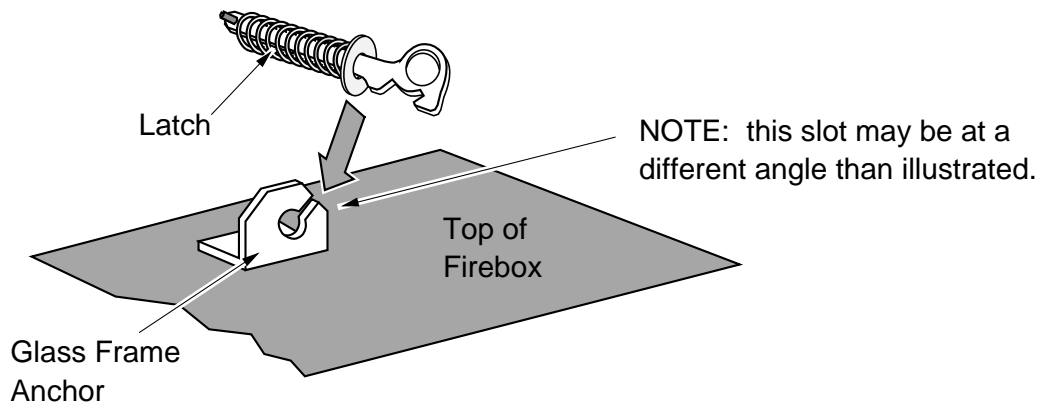

Note how the washer on the latch fits behind the flange on the glass frame anchor.

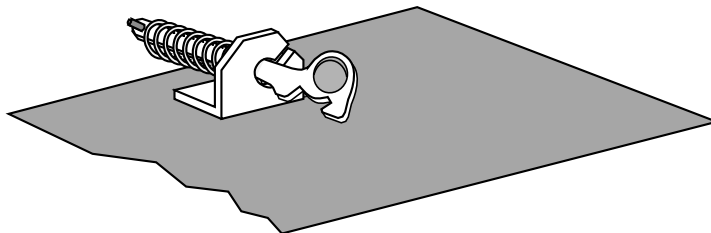

Once fully inserted, turn the latch until it is upright.

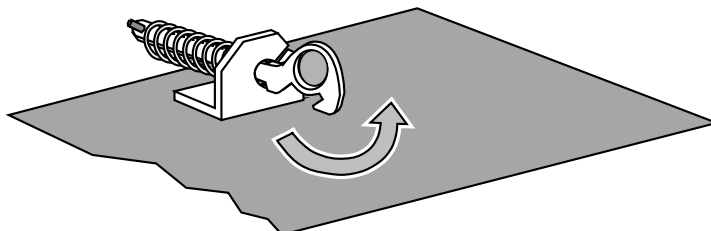

Log Installation

- ! **The logs are fragile, especially after being exposed to heat.**
- Make sure the gas control valve is "OFF" and the heater is cool prior to conducting service.
- Failure to position the parts in accordance with these diagrams or failure to use only parts specifically approved with this appliance may result in property damage or personal injury.
- If using propane (LP), convert the appliance before installing the logs (see page 41).
- The burner must be correctly positioned before installing the logs. Make sure the burner is fully seated and the pilot is properly aligned. See page 41 for details on burner removal.

Ember Placement

Place a layer of embers along the any visible edges of the burner. Also place an ember over the screw on the left side of the burner (see photos below).

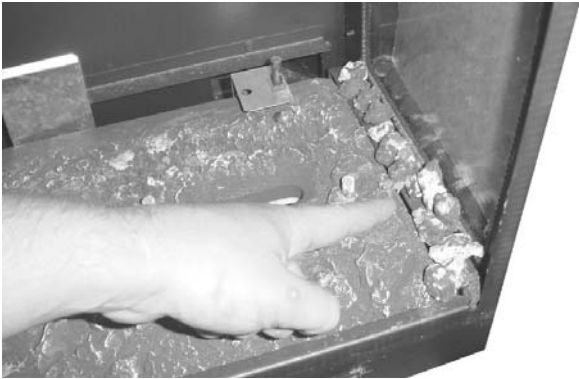

Rear Log Placement

The rear log has two holes on the bottom. Place the log so the pins on the burner insert into the holes on the log (see photos below).

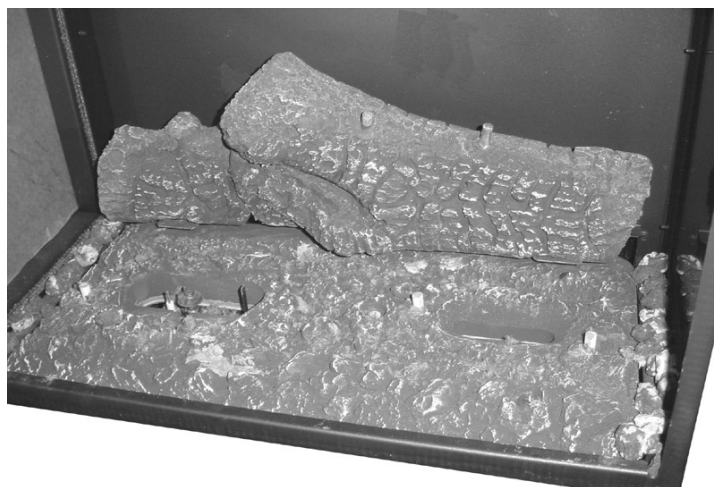

28 Finalizing the Installation (for qualified installers only)

Left Log Placement

The left log has two holes on the bottom. Place the log so the pin on the burner and the metal bracket insert into the holes on the log (see photos below).



Right Log Placement

The right log has two holes on the bottom. Place the log so the pin on the burner and the metal bracket insert into the holes on the log (see photos below).

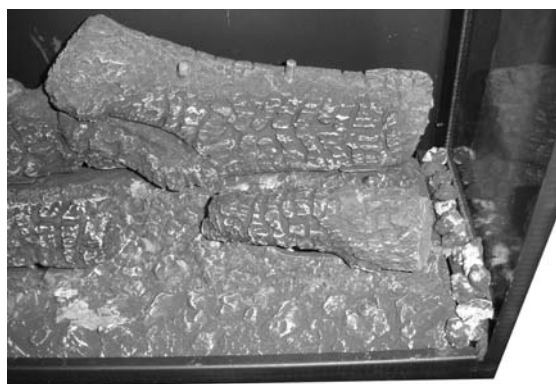
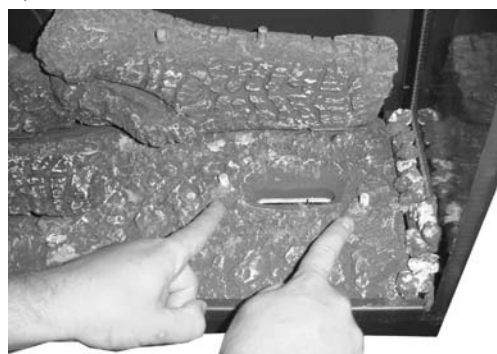

Right Twig Placement

The right twig has a single hole in the bottom that fits over the right pin on the back log (see photos below). The lower side of the twig rests on the right log. Place the twig as shown below.

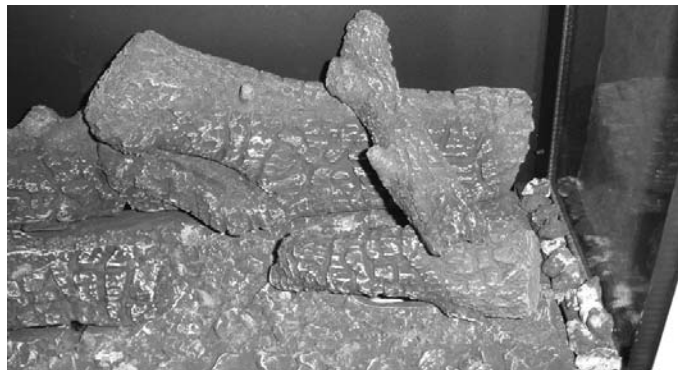
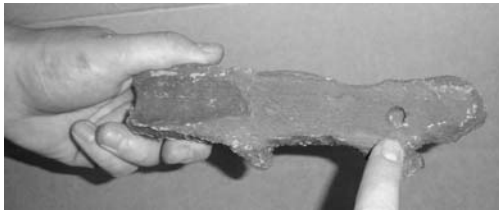

Left Twig Placement

The left twig has two holes in the bottom of it – **for this model, place the log so the left pin on the rear log inserts into the upper hole** (see photo below). The bottom of the log rests on the left log. Place the log as shown below.



Front Ember Chunk Placement

This log set includes a left, center, and right-side ember chunk (see photo below).

Left Ember Chunk

Center Ember Chunk

Right Ember Chunk

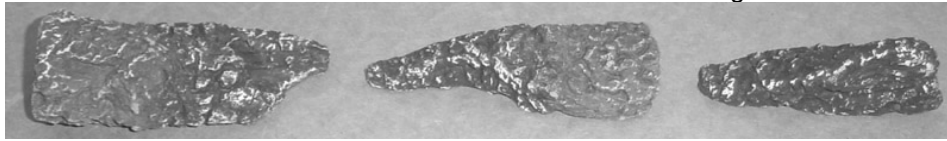

Place the ember chunks as shown in the photos below. Make sure the ember chunks do not cover any burner holes.

Left Side Ember Chunk



Center Ember Chunk



Right Side Ember Chunk



Rockwool Installation

The included rock wool is placed on top of the burner to enhance the glow from the burner. **The rock wool works best when it is applied in a very thin, porous layer.** The best method for applying the rock wool is to brush it on to the burner. Compress a clump of rockwool between your thumb and forefinger. Use a stiff brush to apply a thin layer of rockwool fibers onto the burner. Do not use the entire bag of rockwool. Use only a small amount and save the remainder. Over-use of rockwool will diminish the glow and may cause sooting or other adverse conditions.

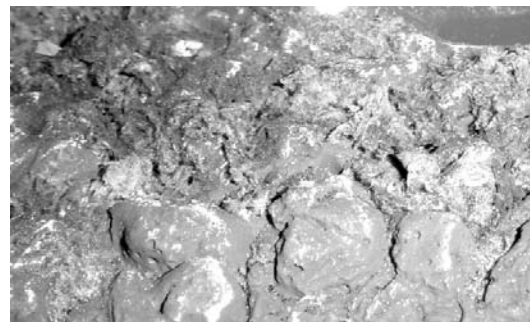

Before You Begin

Warning: Read this entire manual before you use your new stove (especially the section "Safety Precautions" on pages 4 & 5). Failure to follow the instructions may result in property damage, bodily injury, or even death.

Warning: Do not operate appliance with the glass front removed, cracked or broken. Replacement of the glass should be done by a licensed or qualified service person.

Location of Controls - See explanation below

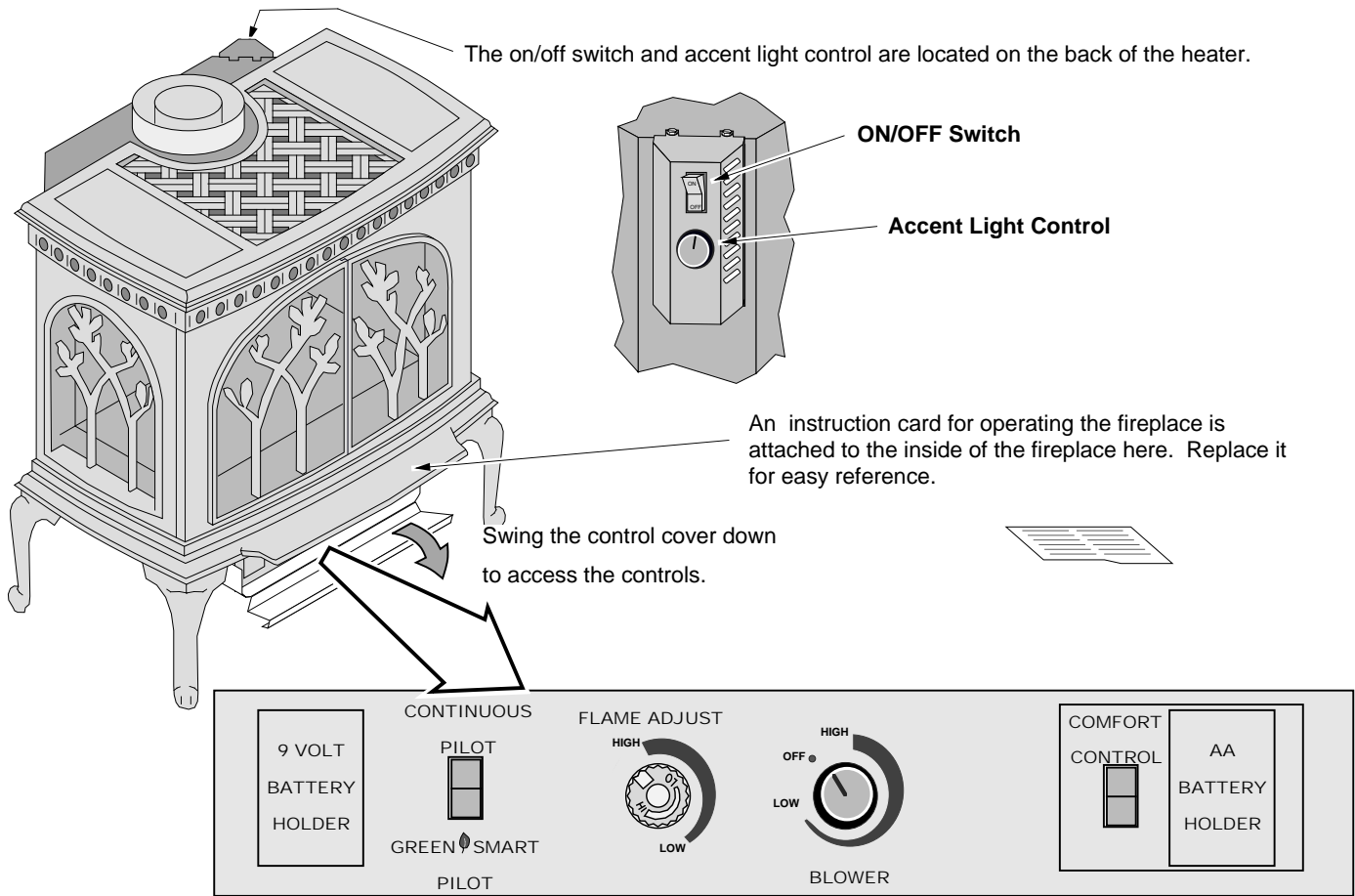

Optional Blower Control	This knob controls the speed of the optional internal convection blower that pushes heated air into the room.
Accent Light	This knob controls the accent lights located behind the logs.
Flame Adjust Knob	This knob controls the flame height from low ("LO") to high ("HI").
Continuous Pilot -- GreenSmart Pilot	This switch controls how the pilot flame works. See the section "Continuous Pilot / GreenSmart Pilot" for details.
Comfort Control	This switch turns the rear burner on and off.
AA Battery Holder	This holder contains 4 AA batteries that allow the stove to operate during power outages.
Main Burner	This switch turns the stove burners on and off.

Starting the Stove for the First Time

- Burn the heater at a high setting with the blower off for an extended period (up to 48 hours). This will cure the painted surfaces. **Fumes** from the paint curing and oil burning off the steel will occur. This is normal. We recommend opening a window to vent the room.
- **Condensation** may appear on the glass each time you start the stove - this is normal.
- **Blue Flames** will occur on the stove when it first comes on. After fifteen minutes the flames will turn a more realistic yellow and orange color.
- Certain installations use a remote, thermostat, or wall switch to turn the stove on and off. If this is the case, leave the ON/OFF switch "ON".
- Verify the power backup and control light batteries are installed (see page 35).

Turning the Stove On and Off

Use the main burner switch to turn the main burner on and off.

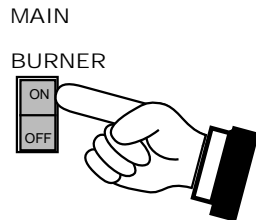

NOTE FOR REMOTES, THERMOSTATS, OR WALL SWITCHES:

The on/off switch on the stove may be required to be left in the ON or OFF position for the stove to operate. Consult your installer or dealer for details.

- Do not place any combustible items on top of or directly in front of the stove, even temporarily. An optional thermostat may start the stove causing a combustible item to ignite.
- If the stove turns on and off frequently while using a standard thermostat, you may want to adjust the flame height down until it produces just enough heat needed.

Comfort Control

The rear portion of the burner may be shut off to lower the heat output and flame size from the burner (this is called the comfort control). Use the comfort control switch to adjust this as desired.

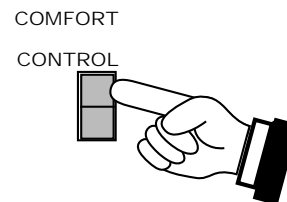

Adjusting the Flame Height

This stove has an adjustable flame to tailor the look and heat output to your specific needs. It is adjusted by turning the flame adjust knob.

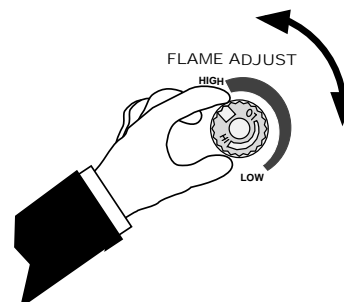

Accent Light

This stove has a built-in accent light that may be turned on and off and dimmed to your preference. Turn the knob to achieve the desired light output.

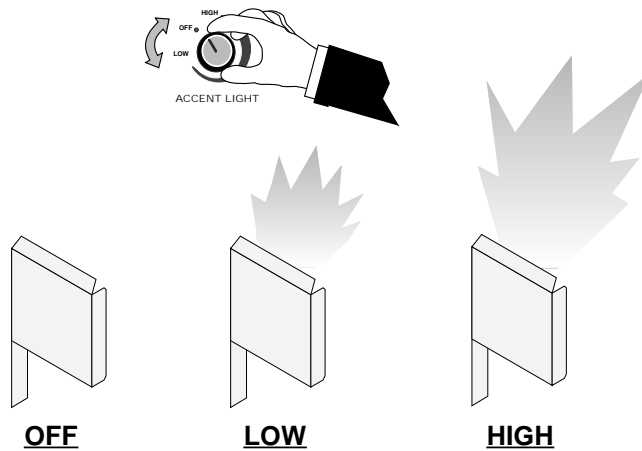

Adjusting the Optional Blower Speed

The blower helps transfer heat from the heater into the room. It will not turn on until the heater is up to temperature (approximately 15 minutes after starting). See the illustration below for instructions on adjusting the blower speed.

NOTE: With the rear burner off (comfort control), the heater may not become hot enough for the blower to turn on.

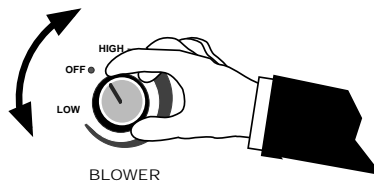

Continuous Pilot / GreenSmart™ Pilot Switch

This stove may run with the pilot continuously running or in GreenSmart (intermittent) mode. For most homeowners, the GreenSmart mode is preferred (this saves fuel, doesn't give off un-needed heat). However, in some situations the homeowner may prefer to switch the stove to continuous pilot. The most typical reasons for switching to continuous pilot are:

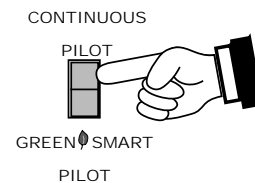

- Very Cold Conditions – in very cold conditions you may notice that the burner does not light quickly, and the flames lift off the burner. If this is situation, we recommend you switch to continuous pilot. This will create a slight draft in the vent, allowing for the burner to light quickly and draft correctly.
- Excessive Condensation on Glass After Startup – certain installations may encounter excessive fogging on the window after stuartup (not just the first time the stove was started). This is an aesthetic condition that may be remedied by switching the stove to continuous pilot.
- Cold Glass or Stove Front – in very cold conditions you may notice that the stove front and glass become very cold. To remedy this, switch the stove to continuous pilot.
- Frequent On / Off Operation – if you are frequently turning the stove on and off, you may wish to leave it in continuous pilot. This allows the burner to turn on more quickly, without pilot ignition delay.

Normal Operating Sounds

Extinction Pops

It is not unusual, especially on Propane (LP) appliances, to experience a "pop" when the burner is shut off.

Pilot Assembly

The pilot flame will make a clicking sound when starting up. If left on, it will make a slight whisper sound.

Gas Control Valve

As the gas control valve is turned on and off you will hear a dull clicking sound. This is the valve opening up and shutting down.

GreenSmart Receiver

The optional GreenSmart receiver will beep when receiving commands from the GreenSmart remote.

AC Adapter

This device makes a light humm that is audible in close proximity.

The appliance may creak with change of temperature -- THIS IS NORMAL.

Blower

This heater has an optional blower to push heated air into the room. You will hear the sound of air movement that increases as the speed is increased.

Blower Snap Disk

This part can produce a clicking sound as it turns the blower on and off.

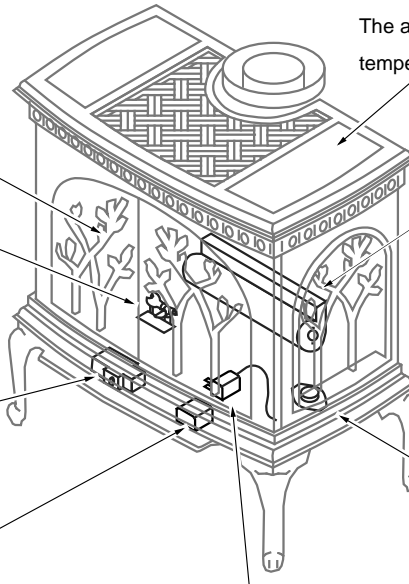

Normal Operating Odors

This appliance has several areas that reach high temperatures. Dust or other particles on these areas may burn and create a burnt-paper smell. This is normal during startup. You may notice the smell is more acute if the appliance was left idle for a long period.

Maintaining Your Stove's Appearance

Painted Surfaces

- Painted surfaces should be cleaned with a duster. If scratches occur, lightly sand the area with fine sandpaper. Clean the area and, with the stove cool, apply one or two thin coats of stove paint to the area (mask the area to avoid overspray). Allow the stove to dry, then turn the stove on to cure the paint (1 hour on medium).

Enamel Surfaces

- Use only soft cloth and water to clean enamel surfaces. To fix chips in the enamel, follow the directions below:
 - Let the stove cool. Clean the area thoroughly.
 - Shake the Travis Enamel Touch-Up thoroughly. Apply to the damaged area.

Patina Surfaces

- The patina finish is a "living" color and will age and antique over time. Some portions of the finish may become slightly dull in appearance, especially over the top where it becomes hot. This is normal. The only cleaning we recommend is a light dusting when the appliance is cool. **DO NOT USE ANY LIQUID, CLEANER, OR ABRASIVES ON THIS FINISH.**

Glass

- Clean the glass with soap and water (do not use abrasive cleaners). Glass removal instructions are on page 25.

Battery Replacement

Power Backup Batteries

Four AA batteries are used as a power backup for the stove in case the household (AC) power goes out. They also power the comfort control feature. These batteries must be inserted into battery holder (make sure they contact the terminals - see the illustration below). The fireplace controller will beep once these batteries start to go dead. Replace batteries before each heating season to insure proper operation.

Control Panel Light Battery

LED lights and a 9v battery are used to illuminate the control panel when the concealment cover is lifted. If the LED lights do not operate, replace the 9v battery (see the illustration below). The battery holder is held in place with Velcro and may be removed for easier access.

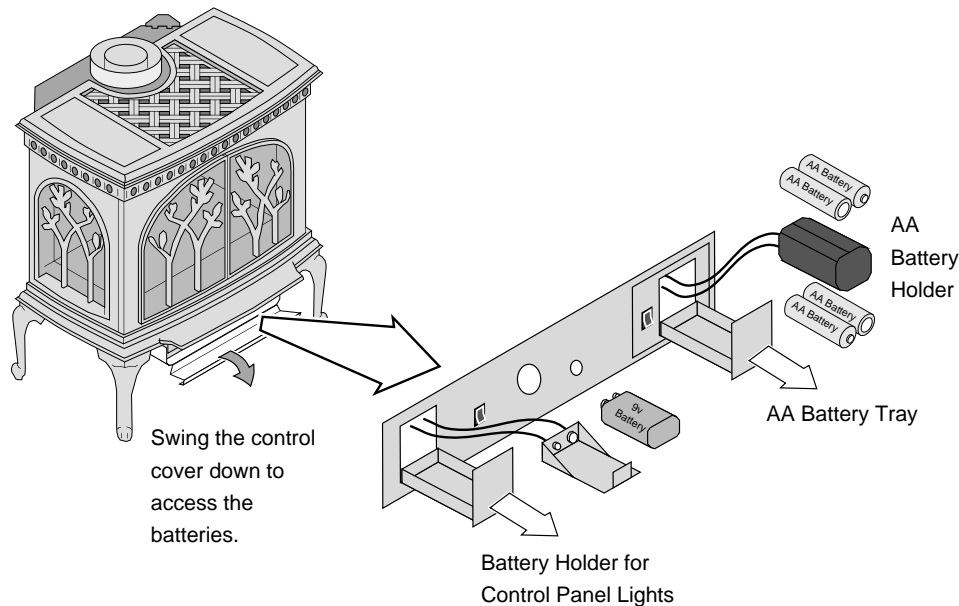

Accent Light Replacement

An accent light is included in your stove to provide additional lighting. This bulb will burn out over time. To replace, follow the directions below:

- Shut off gas to the stove and let it cool for 15 minutes.
- Remove the glass (see page 25) and logs (see page 27).
- Replace the halogen bulb with the following bulb:
(**NOTE:** .Take care to not touch the bulb with your fingers – use foam packing or paper towel to hold the bulb):

35 Watt 120 Volt T4 Halogen Bulb (G6.35 Base)

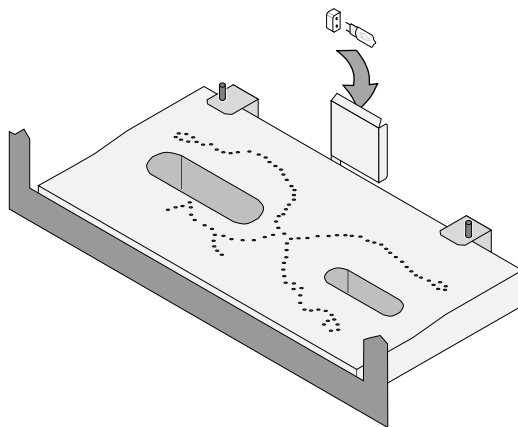

Yearly Service Procedure

- Failure to inspect and maintain the stove may lead to improper combustion and a potentially dangerous situation. We recommend the following procedures be done by a qualified technician.
1. Turn the pilot flame to continuous. It should touch approximately 3/8" of the top of the flame sensor. If it does not, contact your dealer for service.
 2. Shut off gas to the stove and let it cool for 15 minutes. Remove the glass (see page 25).
 3. Remove the log set (**NOTE: the logs are very fragile** - see page 27). If severely deteriorated, replace. Check the logs for sooting. A small amount of soot along the bottom of the logs is normal. If excessive sooting is found, the stove will require adjustment. Contact your dealer.
 4. Inspect the burner and remove any debris.
 - Make sure the burner is not warped, cracked, or damaged.
 - Check the firebox and area around the pilot to make sure there is no warping or damage.
 - If any problem is found, discontinue use and contact your dealer for service.
 5. Replace the log set. Clean and replace the glass. If the glass is damaged, replace. Make sure the gasket along the perimeter of the glass contacts the face of the firebox and forms an air-tight seal. If it does not, re-align or replace the gasket to insure an air-tight seal.
 6. Inspect the area behind the access door. Clean if necessary. Check the gas control valve and the gas lines. If damage is found, discontinue use and contact your dealer for service. Clean the air channels, ducts, and blower (if applicable).
 7. Start the main burner. Inspect the main burner and pilot flame. After 15 minutes the flames should be orange/yellow and not touch the top of the firebox. If the pilot or main burners do not burn correctly, contact your dealer for service. Monitor blower operation.
 8. Remove any debris or vegetation near the vent termination. Contact your dealer if any sooting or deterioration is found near the vent termination. Venting system should be examined by a qualified agency.

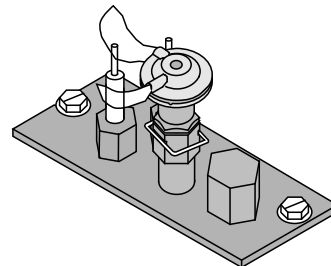

Troubleshooting Table

Problem:	Possible Cause:	Don't Call for Service Until You:
Main Burners Will Not Start	The ON/OFF switch is turned to "OFF" The remote control is not working correctly The thermostat is disconnected or set too low..... No Propane in Tank.....	Turn the ON/OFF switch to "ON" See the remote control instructions See "Thermostat Operation" Check Tank Level
Receiver Beeps	The power backup batteries are dead.....	Replace the batteries (see page 35)
Thermostat Does Not Work	The ON/OFF switch is turned to "OFF" The thermostat is set too low.....	Turn the ON/OFF switch to "ON" Check thermostat
Stove Will Not Distribute Heat	The stove is not getting electricity..... The stove is not up to temperature.....	Check the breaker switch Let the stove burn for at least 15 minutes
Flames Are Too Blue	The stove has just been started..... Improper air shutter adjustment.....	This is normal - see "Starting the Stove for the First Time" Adjust Air Shutter - contact your dealer
Flames Are Too Short (Under 6")	The flame height may be turned too low.....	Turn the flame height to "HI" - See "Adjusting the Flame Height"
Comfort Control Does not Work	The AA batteries may be dead.....	Replace the AA batteries (see page 35)
Thin Layer of Soot Covers the Glass	The logs or coals are placed incorrectly..... Improper air shutter adjustment.....	See "Log Set Installation" Adjust Air Shutter - contact your dealer

Wiring Diagram

Caution: Label all wires prior to disconnection when servicing controls. Wiring errors can cause improper and dangerous operation.

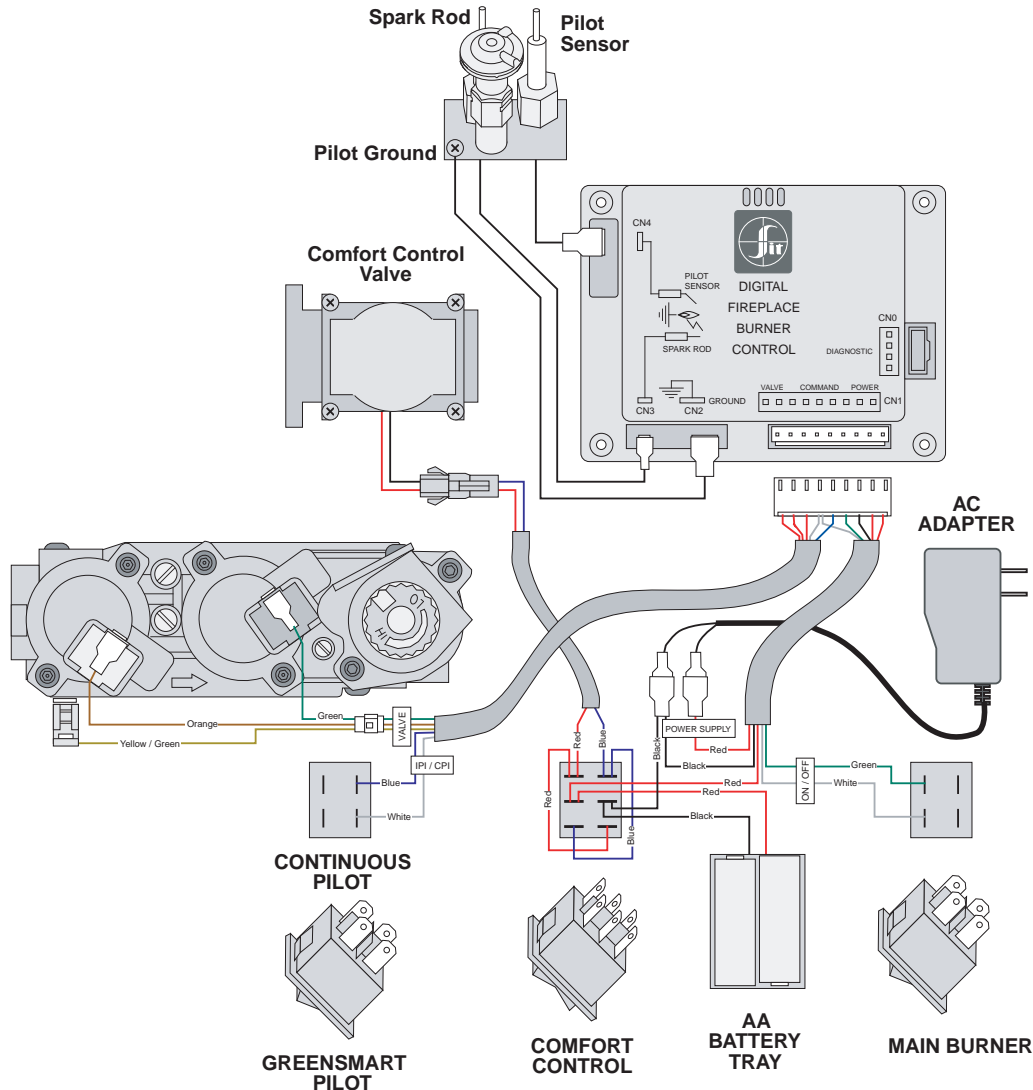

Replacement Parts List

Caution: Use only Travis Industries replacement parts. Do not use substitute materials.

Warning: Do not operate appliance with the glass front removed, cracked, or broken. Replacement of the glass should be done by a licensed or qualified service person.

Contact your local Travis Industries Dealer for a Replacement Parts List

Safety Label

The safety (listing) label is on the back of the stove. A copy is shown below.

MINIMUM CLEARANCES TO COMBUSTIBLES			
Stove Top to Sidelwall	10" (254 mm)	Alcove Min. Height	58" (1473 mm)
Stove Top to Backwall	5" (127 mm)	Alcove Max. Depth	45" (1143 mm)
Stove Top to Cornerwall	5" (127 mm)	Alcove Min. Width	46-3/4" (1187 mm)
Glass Front of Unit	36" (914 mm)		
	L.P.	N.G.	L.P.
Input Rate on "HI" (BTU/Hr)	31,000	31,000	11"
Input Rate on "LO" (BTU/Hr)	12,600	10,700	13"
			10"
			N.G.
		Minimum Inlet Pressure (inches W.C.)	11"
		Maximum Inlet Pressure (inches W.C.)	13"
		Manifold Pressure on "HI" (inches W.C.)	10"
			3.5"

For natural gas when equipped with the following drill size orifice: DMS 50 Front - 47 Rear
 For propane when equipped with the following drill size orifice: DMS 56 Front - 56 Rear

This appliance is equipped for use only at altitudes 0-2000 feet (0-610m) in the USA. In Canada, 0-4500 feet (0-1370m).
 For altitudes above 2000 feet, the vent configuration, orifice, or combination of both may need to be changed.
 See the owner's manual for information on making these changes.

Electrical Rating: 115V, 60 Hz, 1.5 Amps
 Optional Blower: SKU # 99000159

Manufacture Date: 2010 2011 2012

Jan. Feb. Mar. Apr. May Jun. Jul. Aug. Sep. Oct. Nov. Dec.



Report No. RA0999CT.001 Control No. 4000515
 Certified for US and Canada.

Tree of Life GS
 Vented Gas
 Fireplace Heater

Tested to: ANSI Z21.88-2009/CSA 2.33-2009 "Vented Gas Fireplaces Heaters", CGA 2.17-M91, UL 307b-1995 "Gas Burning Heating Appliances for Manufactured Homes", and CSA P4.1-09.

This appliance must be installed in accordance with local codes, if any, if none, follow the National Fuel Gas Code, ANSI Z223.1/NFPA 54, or Natural Gas and Propane Installation Codes, CSA B149.1.

This appliance must be installed in accordance with the current Standard CAN/CSA 22.00 MH, Mobile Housing, in Canada or within the manufacturer's Home Occupancy Area (HOA) as defined in the current Standard CAN/CSA 22.00 MH, Mobile Housing, in the United States or when such a standard is not applicable, ANSI/NFPA 501A, Manufactured Home Installation Standard.

This vented gas fireplace heater is equipped at the factory for use with natural gas. If conversion to propane (L.P.) is desired, the optional factory conversion kit must be used.

This appliance is only for use with the type of gas indicated on the rating plate and may be installed in an aftermarket, permanently located, manufactured home (USA only) where not prohibited by local codes. See owner's manual for details. This appliance is not convertible for use with other gases, unless a certified kit is used.

This vented gas fireplace heater is not for use with air filters.

Keep burner and control compartment clean. See installation and operating instructions accompanying appliance.

This appliance must be properly connected to a venting system in accordance with the manufacturer's installation instructions. Do not connect to a vented coaxial direct vent system to vent this appliance to the exterior. See owner's manual for approved branch venting.

WARNING: Improper installation, adjustment, alteration, service or maintenance can cause injury or property damage. Refer to the instructions manual. Read and follow the safety instructions included with this appliance. For assistance or additional information consult a qualified installer, service agency or the gas supplier.

VENTED GAS FIREPLACE HEATER - NOT FOR USE WITH SOLID FUEL

CAUTION: Hot while in operation. Do Not Touch. Severe burns may result. Keep children, clothing, furniture, gasoline and other liquids having flammable vapors away. Do not operate this appliance with glass removed, cracked or broken. Replacement of the panel(s) should be done by a licensed or qualified service person.

Limited 7 Year Warranty

Register your TRAVIS INDUSTRIES, INC. Limited 7 Year Warranty online at traviswarranty.com, or complete the enclosed Warranty card and mail it within **ten (10)** days of the appliance purchase date to: TRAVIS INDUSTRIES, INC., 4800 Harbour Pointe Blvd. SW, Mukilteo, WA 98275. TRAVIS INDUSTRIES, INC. warrants this gas appliance (appliance is defined as the equipment manufactured by Travis Industries, Inc.) to be defect-free in material and workmanship to the original purchaser from the date of purchase as follows:

Check with your dealer in advance for any costs to you when arranging a warranty call.
Mileage or service charges are not covered by this warranty. This charge can vary from store to store.

<u>Component</u>	Years 1 & 2 Parts & Labor	Years 3 Through 5 Parts & Labor	Years 6 & 7 Parts Only
<u>Burner Assembly</u> Burner Pan Assembly, Air Shutter Assembly, Main Burner Orifice	✓		
<u>Electrical Assembly (within heater structure):</u> Wiring harness, snap discs, rheostat speed control	✓		
<u>Gas Control Assembly</u> Adjustable control valve, fireplace controller, pilot assembly and pilot wiring	✓		
<u>Glass</u> Glass (breakage from thermal shock)	✓		
<u>Ceramic Logs</u> Log Set, Embers	✓		
<u>Gold, Nickel & Copper Plating</u> Face & Door (see "Conditions and Exclusions" # 9)	✓		
<u>Enamel Finish</u> Warranted against peeling or fading, excluding chipping, mechanical abrasion, or crazing.	✓		
<u>Accessories</u> Firebacks, Power Heat Ducts, Andirons, etc...	✓		
<u>One-Way Freight Allowance</u> One-way freight allowance on pre-authorized repair done at factory is covered.	✓	✓	
<u>Convection Heat Exchanger</u> Convection heat exchanger assembly	✓	✓	
<u>Firebox Assembly</u> Adjustable Air Restrictor, Pressure Relief Mechanisms, Glass Attachment Mechanism	✓	✓	✓

EXCLUDED COMPONENTS:

Paint, Gasketing, and Accent Light Bulbs

CONDITIONS & EXCLUSIONS

- This new gas appliance must be installed by a qualified gas appliance technician. It must be installed, operated, and maintained at all times in accordance with the instructions in the Owner's Manual. Any alteration, willful abuse, accident, neglect, or misuse of the product shall nullify this warranty.
- This warranty is nontransferable, and is made to the ORIGINAL purchaser, provided that the purchase was made through an authorized TRAVIS dealer.
- Discoloration and some minor expansion, contraction, or movement of certain parts and resulting noise, is normal and not a defect and, therefore, not covered under warranty. The installer must ensure the appliance is burning as per the rating tag at the time of installation. Over-firing (operation above the listed BTU rate) of this appliance can cause serious damage and will nullify this warranty.
- The warranty, as outlined within this document, does not apply to the chimney components or other Non-Travis accessories used in conjunction with the installation of this product. If in doubt as to the extent of this warranty, contact your authorized TRAVIS retailer before installation.
- Travis Industries will not be responsible for inadequate performance caused by environmental conditions such as nearby trees, buildings, roof tops, wind, hills or mountains or negative pressure or other influences from mechanical systems such as furnaces, fans, clothes dryers, etc.
- This Warranty is void if:
 - The unit has been operated in atmospheres contaminated by chlorine, fluorine or other damaging chemicals.
 - The unit is subject to submersion in water or prolonged periods of dampness or condensation.
 - Any damage to the unit, combustion chamber, heat exchanger or other components due to water, or weather damage which is the result of, but not limited to, improper chimney/venting installation.
- Exclusions to this 7 Year Warranty include: injury, loss of use, damage, failure to function due to accident, negligence, misuse, improper installation, alteration or adjustment of the manufacturer's settings of components, lack of proper and regular maintenance, damage incurred while the appliance is in transit, alteration, or act of God.
- This 7 Year warranty excludes damage caused by normal wear and tear, such as paint discoloration or chipping, worn or torn gasketing, corroded or cracked logs, embers, etc. Also excluded is damage to the unit caused by abuse, improper installation, modification of the unit, drilling of the orifices, or the use of fuel other than that for which the unit is configured. Units are shipped for natural gas and must be converted to propane using the included conversion kit. Confirm fuel configuration with your installer.
- Damage to gold or nickel surfaces caused by fingerprints, scratches, melted items-, or other external sources left on the gold or nickel from the use of cleaners other than denatured alcohol is not covered in this warranty.
- TRAVIS INDUSTRIES, INC. is free of liability for any damages caused by the appliance, as well as inconvenience expenses and materials. Incidental or consequential damages are not covered by this warranty. In some states, the exclusion of incidental or consequential damage may not apply.
- This warranty does not cover any loss or damage incurred by the use or removal of any component or apparatus to or from the gas appliance without the express written permission of TRAVIS INDUSTRIES, INC. and bearing a TRAVIS INDUSTRIES, INC. label of approval.
- Any statement or representation of TRAVIS products and their performance contained in TRAVIS advertising, packaging literature, or printed material is not part of this 7 year warranty.
- This warranty is automatically voided if the appliance's serial number has been removed or altered in any way. If the appliance is used for commercial purposes, it is excluded from this warranty.
- No dealer, distributor, or similar person has the authority to represent or warrant TRAVIS products beyond the terms contained within this warranty. TRAVIS INDUSTRIES, INC. assumes no liability for such warranties or representations.
- Travis Industries will not cover the cost of the removal or re-installation of hearths, facing, mantels, venting or other components.
- If for any reason any section of this warranty is declared invalid, the balance of the warranty remains in effect and all other clauses shall remain in effect.
- THIS 7 YEAR WARRANTY IS THE ONLY WARRANTY SUPPLIED BY TRAVIS INDUSTRIES, INC., THE MANUFACTURER OF THE APPLIANCE. ALL OTHER WARRANTIES, WHETHER EXPRESS OR IMPLIED, ARE HEREBY EXPRESSLY DISCLAIMED AND PURCHASER'S RECOURSE IS EXPRESSLY LIMITED TO THE WARRANTIES SET FORTH HEREIN.**

IF WARRANTY SERVICE IS NEEDED:

- If you discover a problem that you believe is covered by this warranty, you MUST REPORT it to your TRAVIS dealer WITHIN 30 DAYS, giving them proof of purchase, the purchase date, and the model name and serial number.
- Travis Industries has the option of either repairing or replacing the defective component.
- If your dealer is unable to repair your appliance's defect, he may process a warranty claim through TRAVIS INDUSTRIES, INC., including the name of the dealership where you purchased the appliance, a copy of your receipt showing the date of the appliance's purchase, and the serial number on your appliance. At that time, you may be asked to ship your appliance, freight charges prepaid, to TRAVIS INDUSTRIES, INC. TRAVIS INDUSTRIES, INC., at its option, will repair or replace, free of charge, your TRAVIS appliance if it is found to be defective in material or workmanship within the time frame stated within this 7 year warranty. TRAVIS INDUSTRIES, INC. will return your appliance, freight charges (years 1 to 5) prepaid by TRAVIS INDUSTRIES, INC., to your regional distributor, or dealership.
- Check with your dealer in advance for any costs to you when arranging a warranty call. Mileage or service charges are not covered by this warranty. This charge can vary from store to store.

LP Conversion Instructions

Install the conversion kit prior to installing the gas line to ensure proper gas use.

- 1 Remove the glass (see page 25). Remove the logs and embers (if installed - page 27)
- 2 Remove the burner (see below). Grasp the burner with both hands and lift it straight up and out of the firebox.

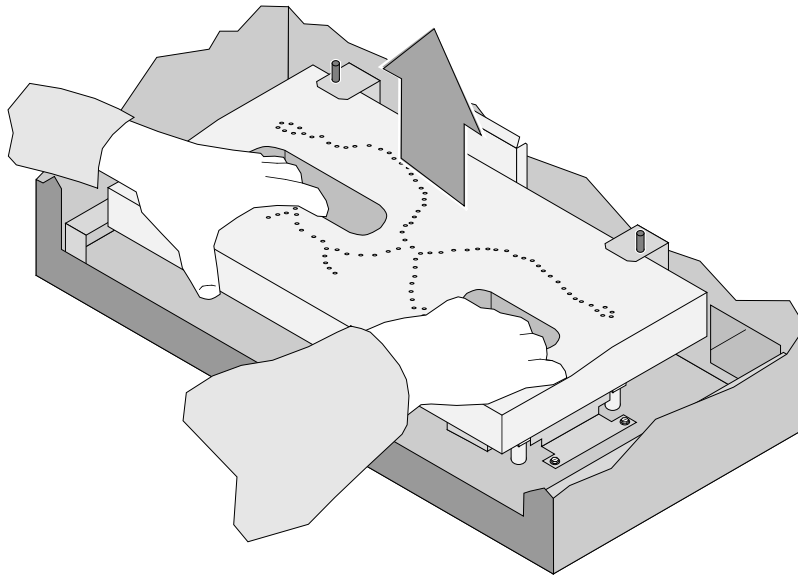

- 3 Remove the manifold cover to access the burner orifices (see below).

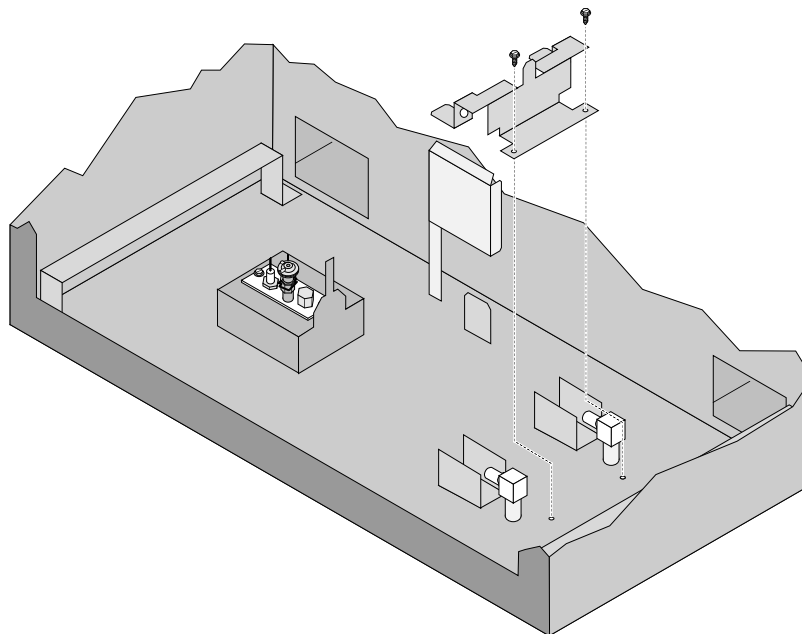

4 Follow the directions below to replace the orifices.

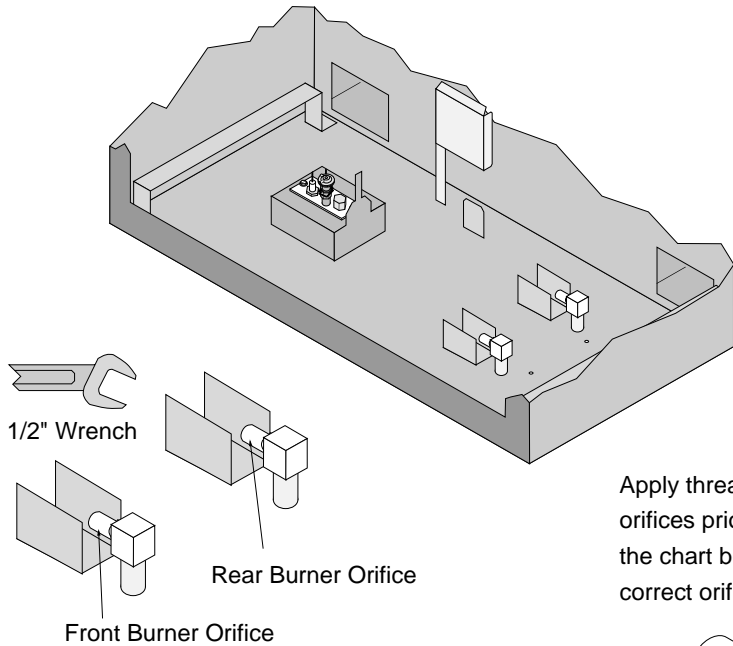

(a) Use a 1/2" open end wrench to unscrew the two orifices.

(c) Screw each LP orifice in so the orifice protrudes 15/16" (24mm) (indicating full insertion).

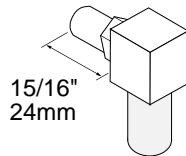

(b) Apply thread sealant to the LP orifices prior to installation. Use the chart below to identify the correct orifices.



	NG	LP
Front	#50	#56
Rear	#47	#56

5 Remove the rivet from the left side of the burner and place it on the right side (see illustration below).

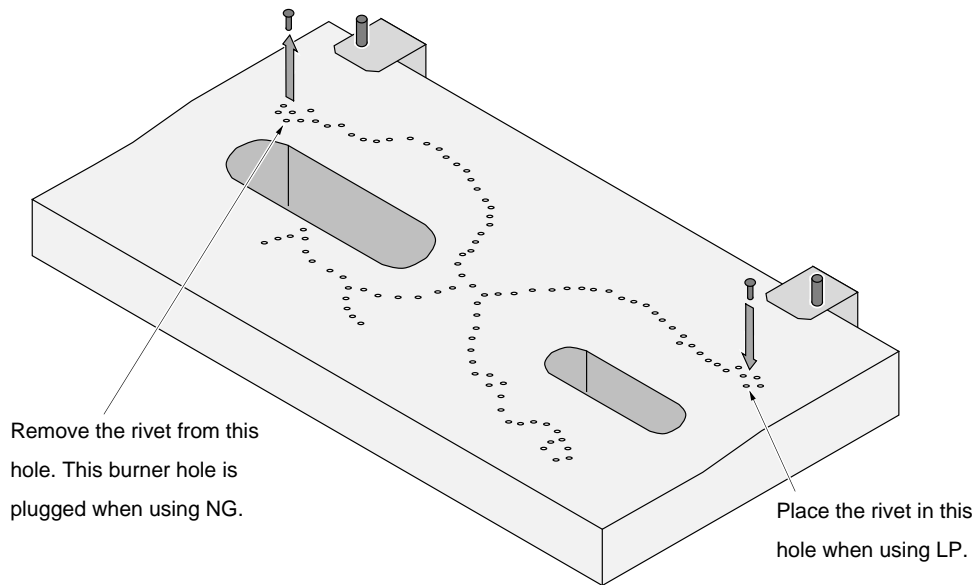

6 Remove the pilot orifice following the instructions below. Replace with the propane pilot orifice

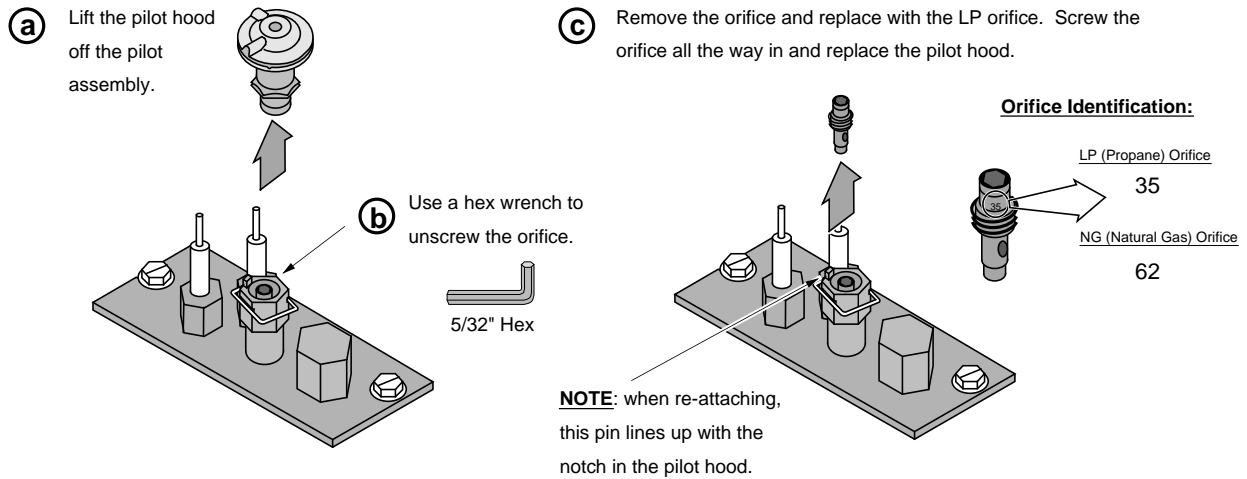

7 Replace the firebox components. Install the logs and embers. Replace the glass.

8 Remove and discard the screws (see "a" below) holding the stock regulator in place (see "b" below). Remove the stock regulator and gasket (see "c" below). Place the LP regulator in place, making sure the pre-fitted gasket (see "c" below) is in place. NOTE: There is a label on the base of the regulator knob indicating regulator type (NG or LP). Secure the regulator with the screws included with the regulator – tighten to 25 lb-in of torque. Place the included label on the valve body where it can be easily seen to insure proper identification. NOTE: Leak test this area after the heater is installed, gas is connected, and the main burner is lit.

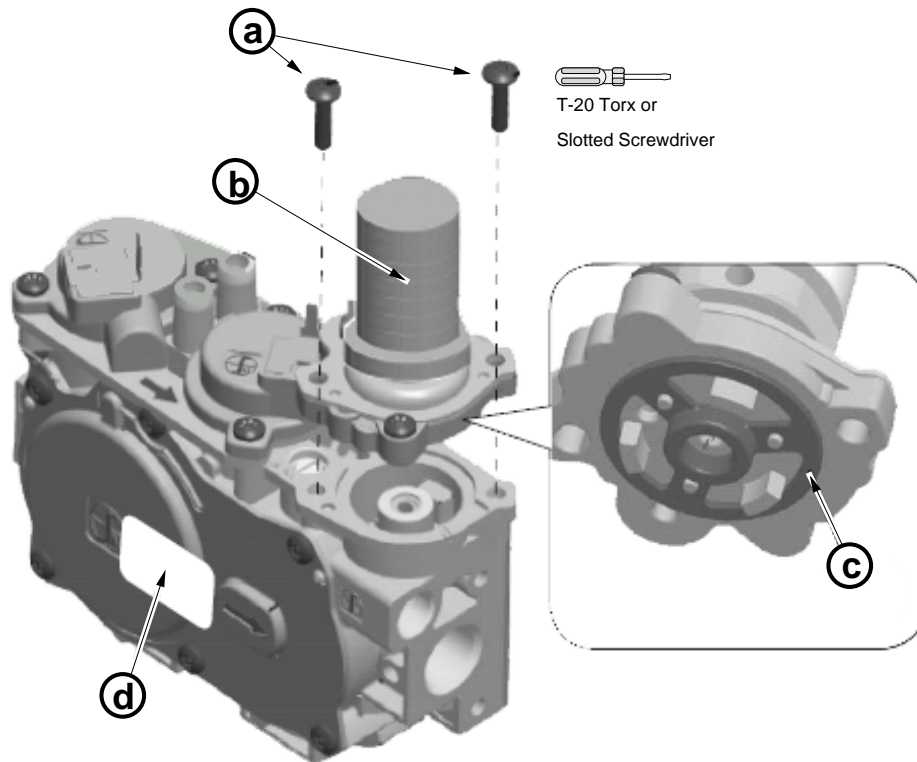

9 Make the gas line connection, bleed the gas line (if applicable), start the heater and thoroughly leak-test all gas connections and the gas control valve.

GreenSmart™ Remote Control Installation

Packing List

- Transmitter
- Receiver (with Cover Plate & Switch)
- Fan Control Module
- Velcro
- LP or NG Stepper Motor (with screws and label - attaches to Valve)
- Wire Harness
- (2) Power Leads
- (4) AA Batteries (inside receiver box)
- (2) #8 x ½" Machine Screws
- (2) Wire Ties
- Torx T-20 Wrench
- Wall Mount (for placing the transmitter on a wall)
- (2) Drywall anchors (for wall mount)
- (2) #8 x 3/8" Type B Screws

Transmitter

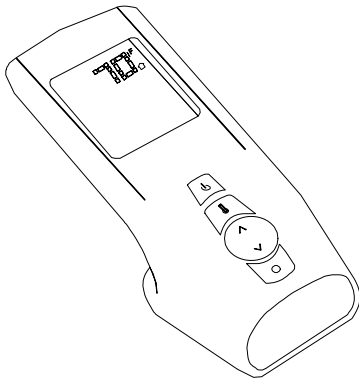

Fan Control Module

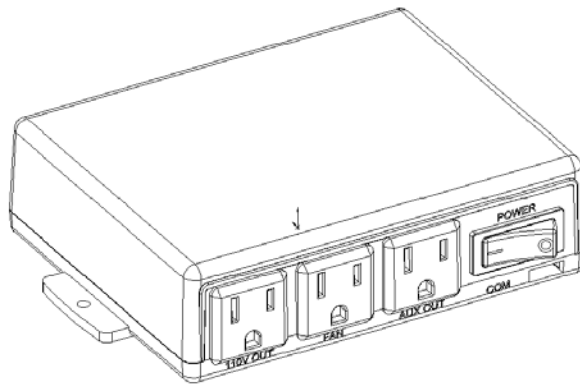

Receiver

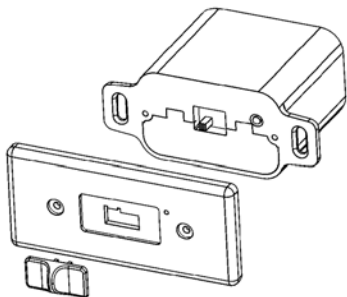

Stepper Motor

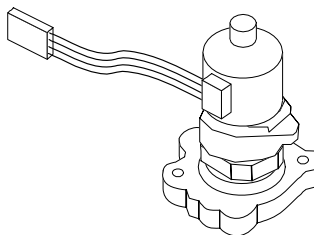

Transmitter Wall Mount

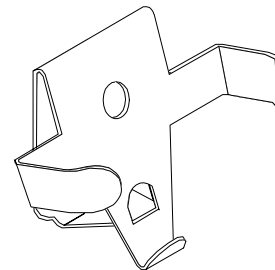

Overview

The GreenSmart remote includes a new wiring harness that replaces the stock wiring harness. Before installing, familiarize yourself with the stock and updated wiring diagrams (see the illustrations on this page and the following page).

Stock Wiring Diagram

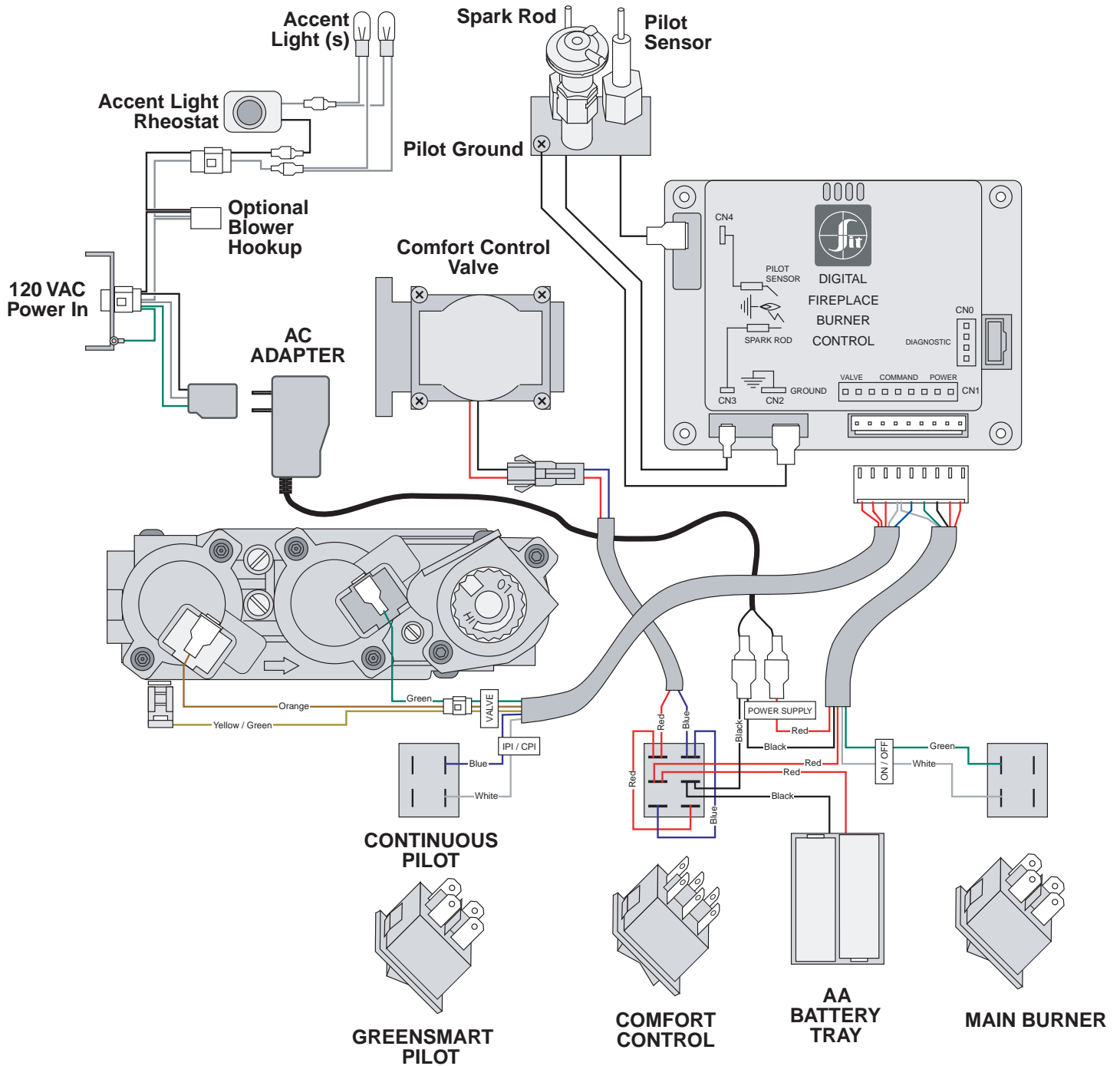

GreenSmart Wiring Diagram

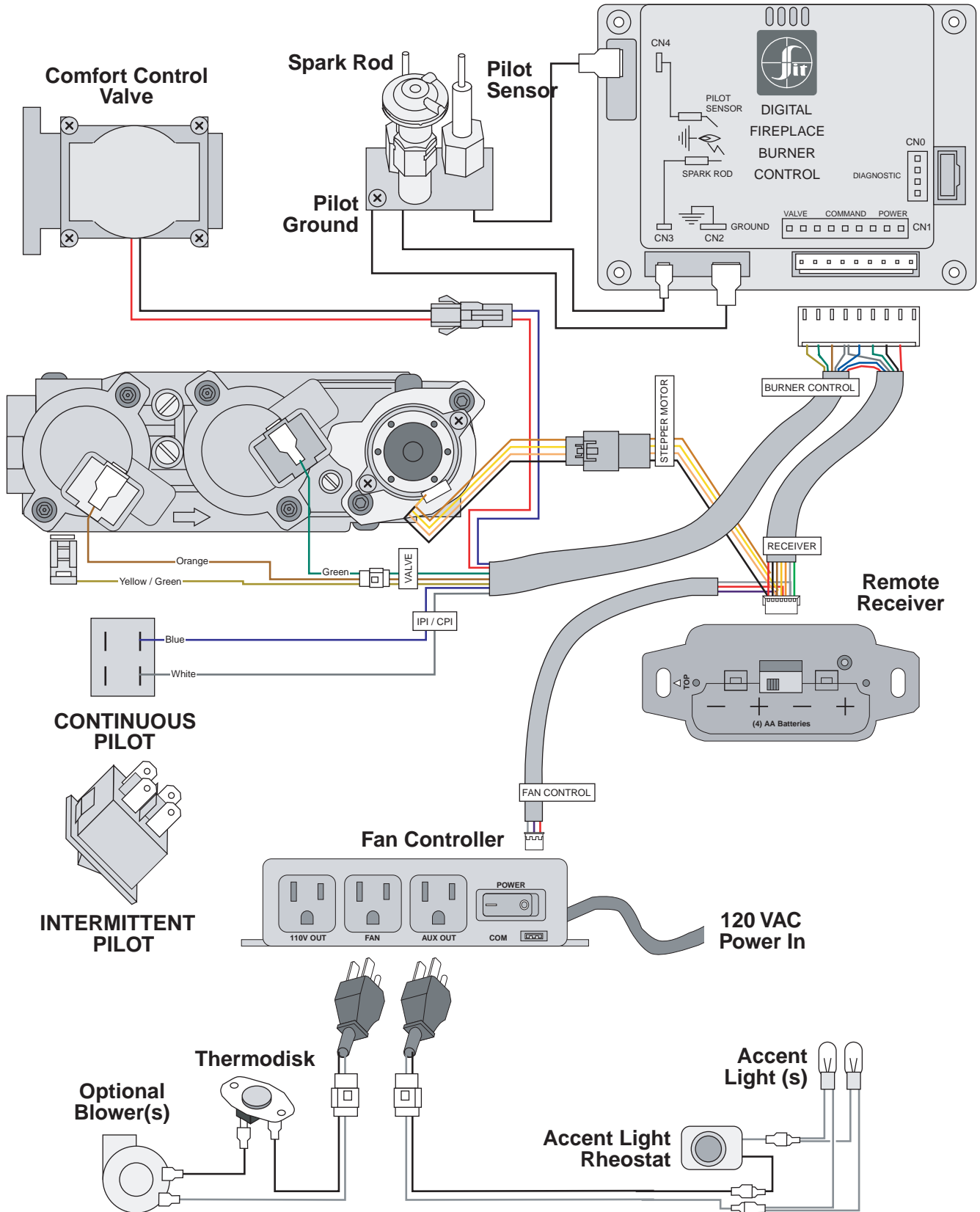

Installation

WARNING: Make sure power to the stove has been shut off prior to installation.

NOTE: Refer to the wiring diagram on page 46 while making wiring harness connections.

- 1 Loosen the bottom panel attachment screws (there are two on each side see Figure 1). Slide the bottom panel back and place it below the stove (see Figure 2). This allows for access to the controls under the stove

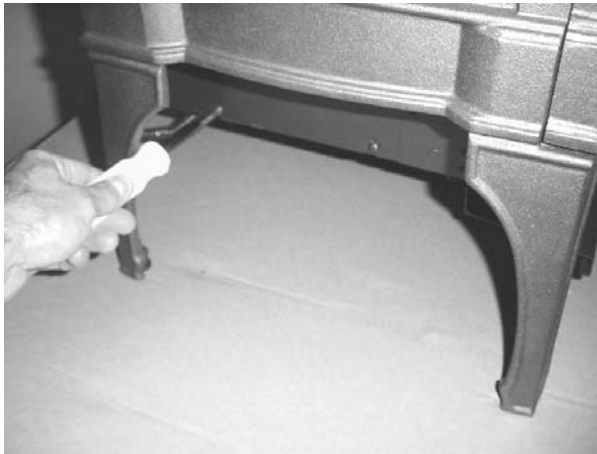

Figure 1

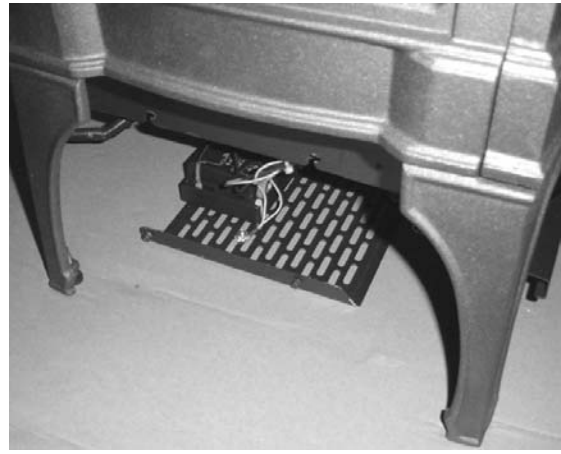

Figure 2

- 2 Remove the four screws holding the control panel to the front of the stove (see Figure 3). Carefully remove the control panel, making sure you do not disconnect any wiring (see Figure 4).

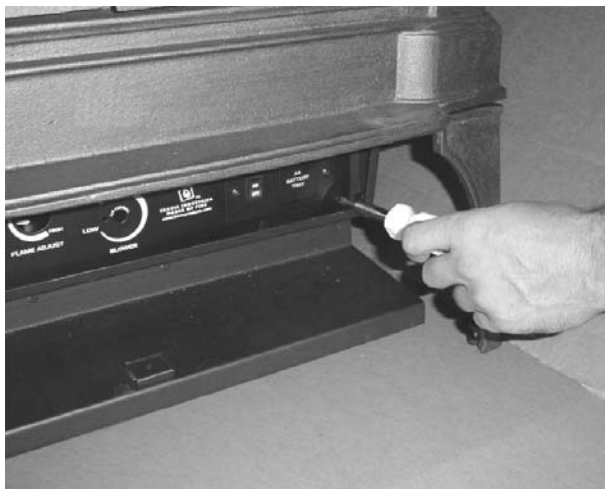

Figure 3

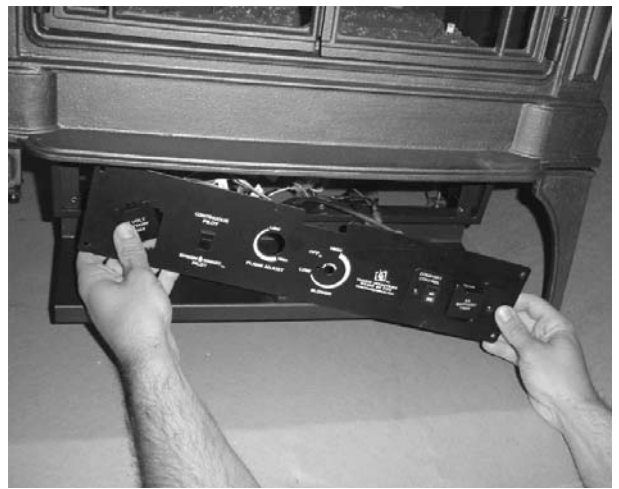

Figure 4

- 3 Unplug the ac adapter from the power harness (see Figure 5). You can leave the ac adapter plugged into the wiring harness.

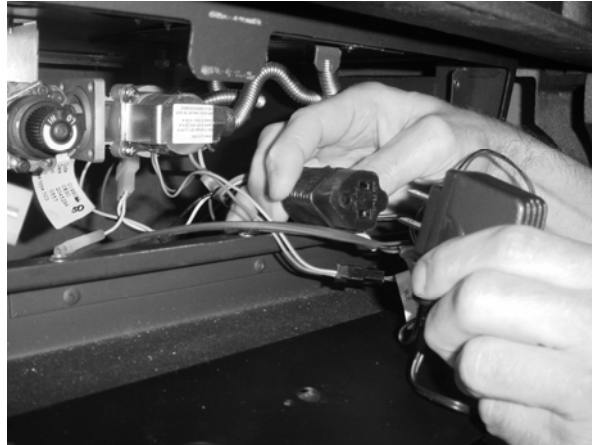

Figure 5

- 4 Disconnect the molex connector leading to the gas control valve (see Figure 6).
WARNING: The tabs on the gas control valve are fragile. Take care when removing the molex connector to not pull or damage the wires or tabs.

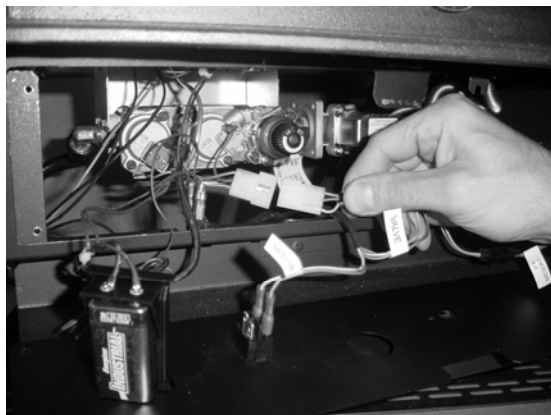

Figure 6

- 5 Disconnect the two leads on the back of the control panel for the IPI / CPI switch (continuous pilot / greensmart pilot – see Figure 7).

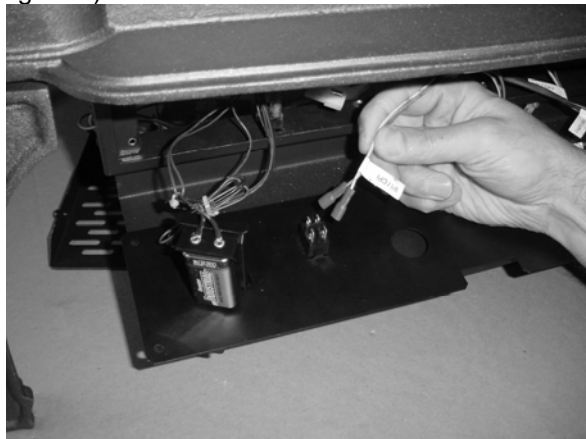

Figure 7

- 6 Disconnect the comfort control valve connection (see Figure 8). Disconnect the burner control connector from the fireplace burner control (see Figure 9).

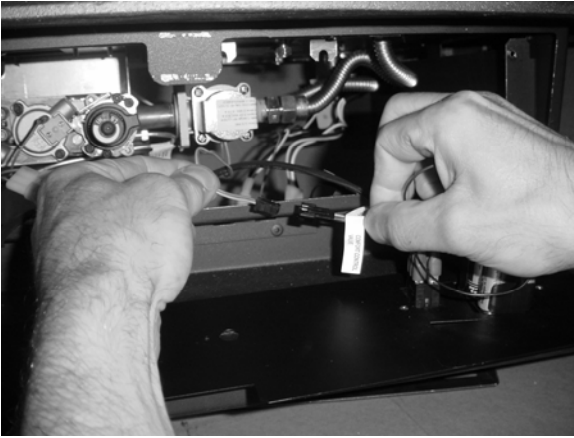

Figure 8

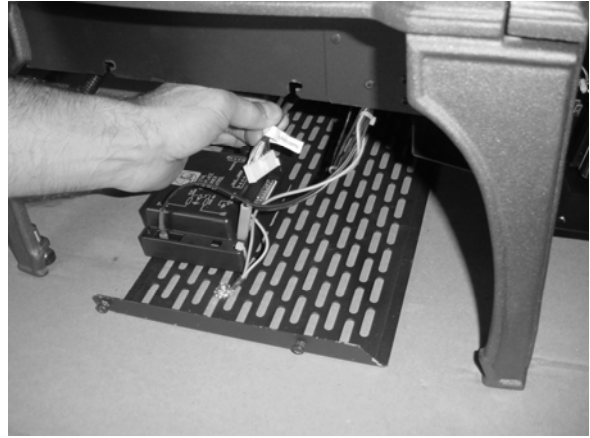

Figure 9

- 7 Disconnect the on/off switch wires (labeled ON/OFF - see Figure 10). Unscrew the on/off/battery plate from the control panel (see Figure 11).

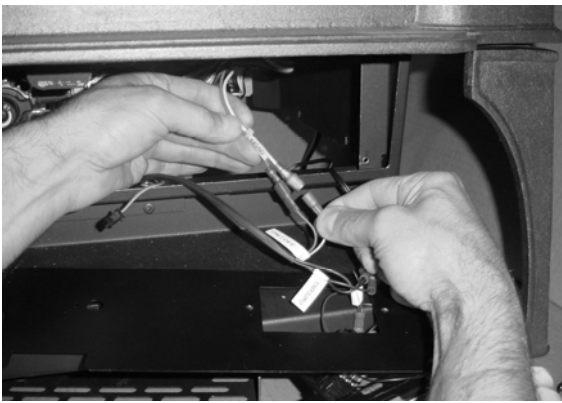

Figure 10



Figure 11

- 8 Pull the plate and wiring forward (see Figure 12). Un-hook the wires from the wire-locks and remove the wiring harness, plate, battery holder, and ac adapter (see Figure 13). These items may be discarded.

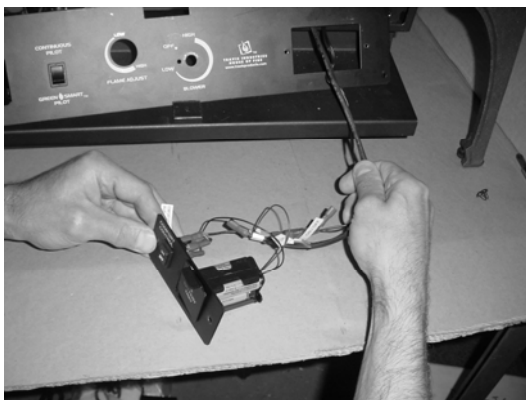

Figure 12

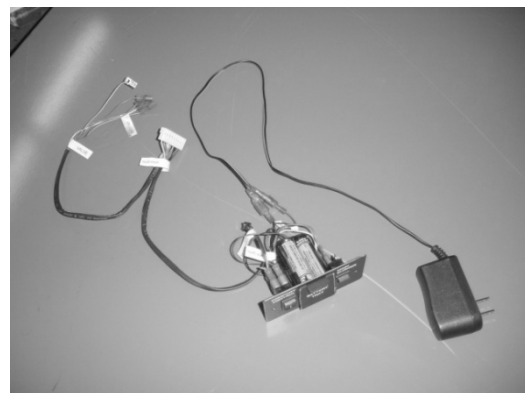

Figure 13

- 9 Use the included torx wrench to remove the stock regulator (see Figure 14). The old regulator may be discarded.



Figure 14

- 10 The stepper motor (adjustable regulator) has an installation sheet included with it – make sure to follow all of the directions. Place the stepper motor on the gas control valve (see Figure 15) – **MAKE SURE IT IS CORRECTLY ORIENTED.** Secure using the screws included with the motor (see Figure 16) – tighten to 25 Lb-inches. Leak test this area after installation to verify proper installation.

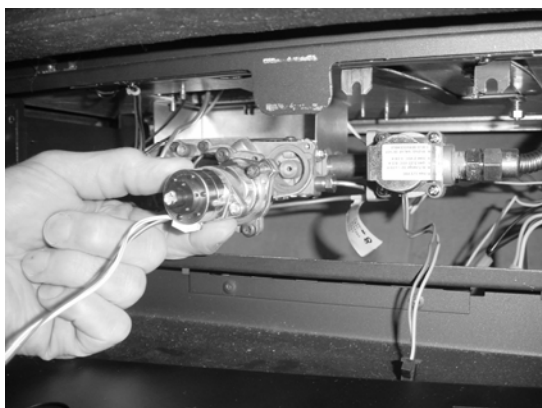

Figure 15



Figure 16

- 11 Place the GreenSmart wiring harness in front of the stove, noting the position of each connector (see Figure 17).

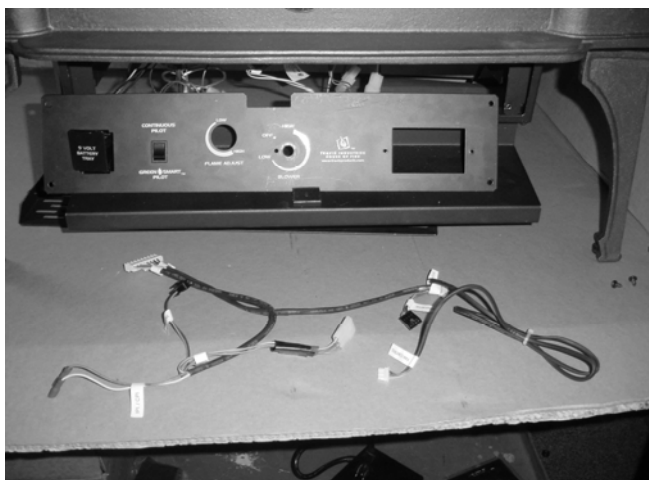

Figure 17

- 12 Attach the wiring harness to the burner control (see Figure 18). Attach the gas control valve moxex connector (see Figure 19).



Figure 18



Figure 19

- 13 Attach the blue and white wires to the IPI/CPI switch (see Figure 20). Connect the wiring harness to the stepper motor (see Figure 21).

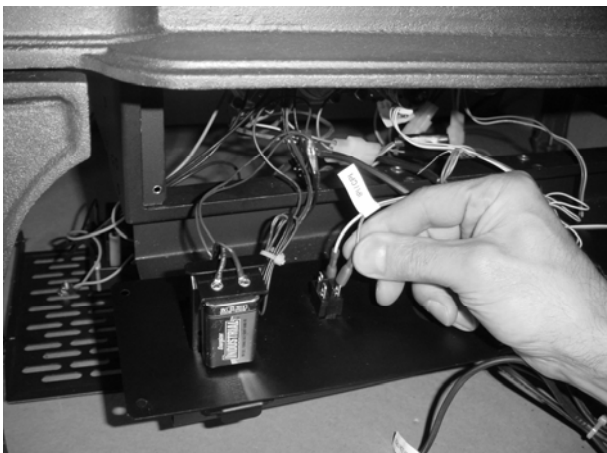

Figure 20

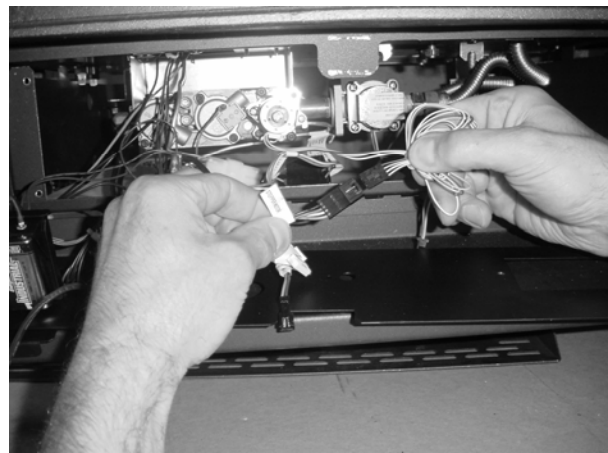

Figure 21

- 14 Attach the wiring harness to the comfort control valve connection (see Figure 22).



Figure 22

- 15 Place the fan controller on the bottom panel as shown in Figure 23. Make sure the control module is positioned with the power cord to the right and the module at the back edge of the bottom panel.



Figure 23

- 16 Attach the power cord from the fan controller to the AC connection (see Figure 24). Attach the connector labeled "FAN CONTROL" on the wiring harness to the fan control module (see Figure 25). **MAKE SURE TO TURN THE FAN CONTROLLER ON** ("-" SYMBOL).



Figure 24

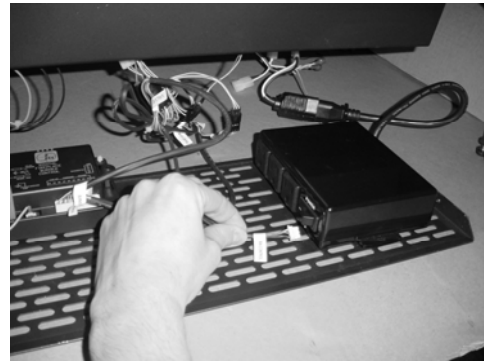

Figure 25

- 17 Access the back of the stove and disconnect the power lead from accent light (see Figure 26). Connect the accent light wiring to the power lead included with this kit (see Figure 27).

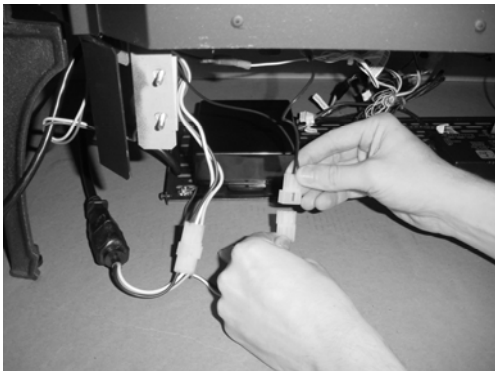

Figure 26

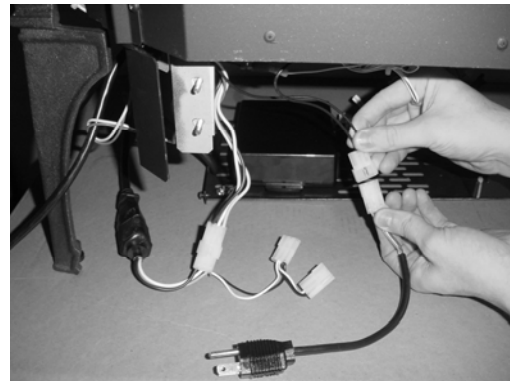

Figure 27

- 18 Attach the accent light power lead to the fan controller in the “AUX OUT” receptacle (see Figure 28).

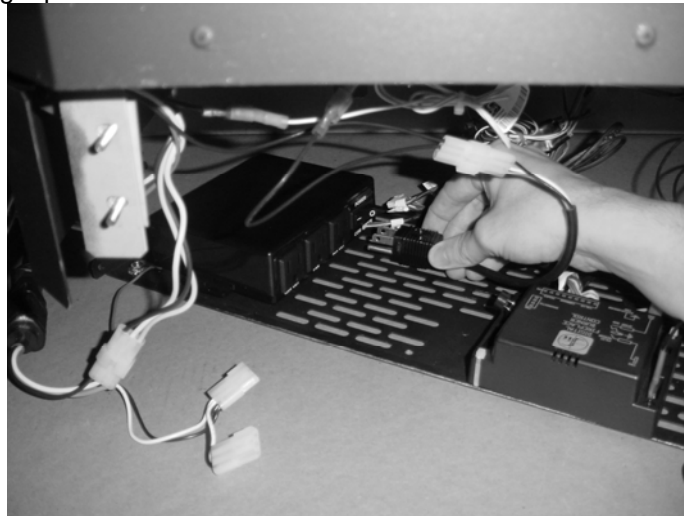

Figure 28

NOTE: If using the optional fan, you will want to disconnect its power lead and connect it to the extra power lead included with this kit, then connect it to the “FAN” receptacle on the fan controller. See the blower installation instructions for details.

- 19 Slide the receiver through the control panel and attach the “RECEIVER” connector to the receiver (see Figure 29). Attach the control panel to the stove using the four screws removed earlier (see Figure 30).



Figure 29

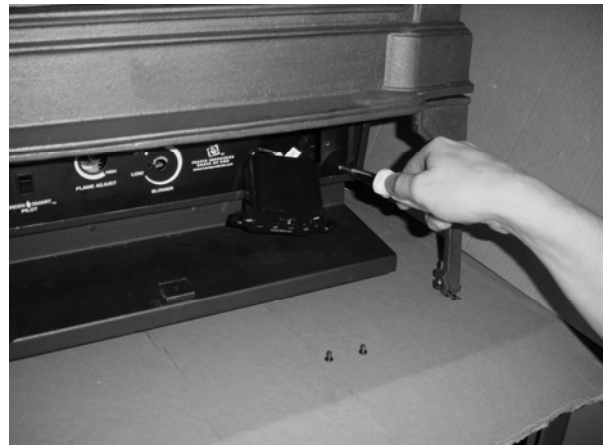

Figure 30

- 20 Attach the receiver to the control panel with the two #8 machine screws (Figure 31).



Figure 31

- 21 Re-attach the bottom plate to stove, taking care to prevent any wiring from being pinched (see Figure 32). Use the included wire ties, if necessary, to keep all wiring from contacting any hot or moving components.

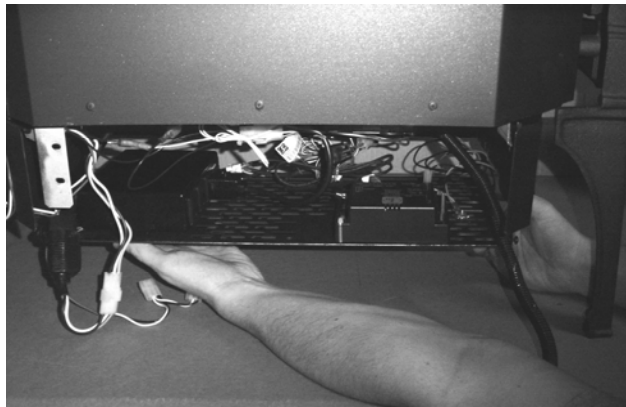

Figure 32

- 22 Place batteries into the receiver and transmitter (see Figure 33). Calibrate the receiver to the transmitter (see Figure 34 - use a paperclip to press the "PRG" button, let it beep, then press any button on the transmitter - the receiver should beep 5 times - see the operating instructions for further details).

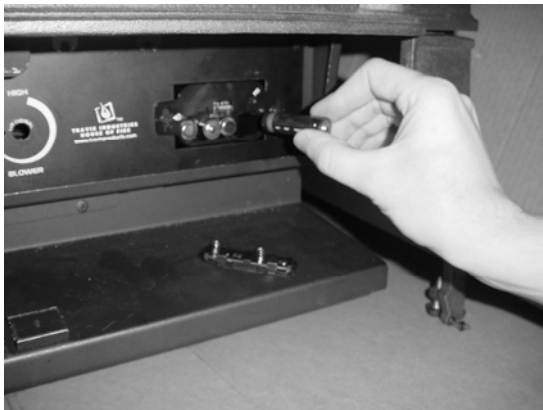

Figure 33



Figure 34

- 23 Place the receiver coverplate (and switch) over the receiver (see Figure 35) and attach with the two screws included with the receiver (see Figure 36)



Figure 35



Figure 36

- 24 A wall mount is included with this kit for the remote. It may be mounted to the wall for easy access and storage. Use the included drywall anchors (and screws) to secure it to the wall (see Figure 37).

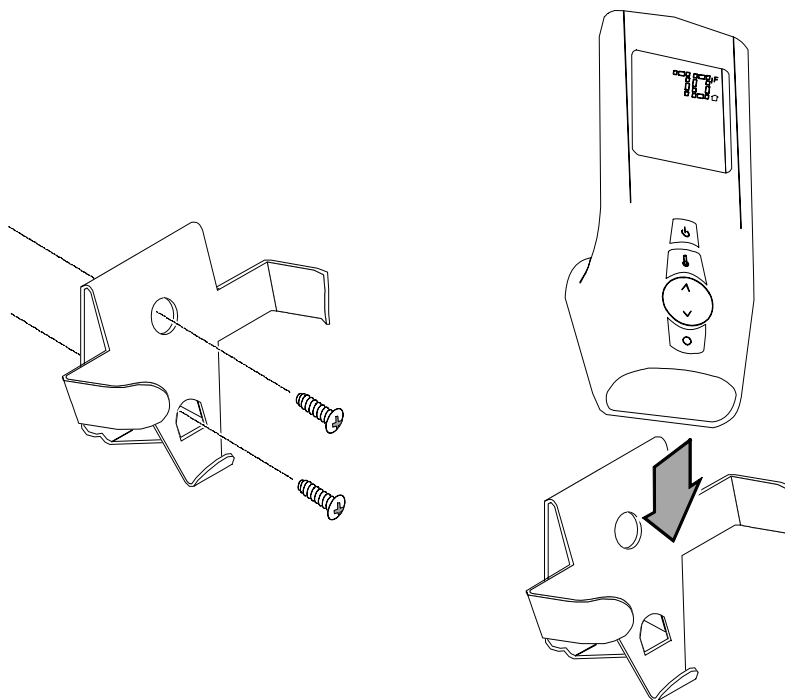

Figure 37

- 25 Restore power to the stove and test operation of the remote (see the instructions included with the remote).

Approved Vent Configurations	13	Installation Options	6
Adjusting the Blower Speed.....	33	Items Required for Installation	7
Adjusting the Flame Height.....	32	Leaking Gas.....	See Inst. on Cover
Air Shutter Adjustment	24	Listing Information	39
Altitude Considerations	12	Location of Controls.....	31
Blower Control.....	33	Log Set Installation and Removal.....	27
BTU Input	6	Maintenance	35
BTU Output	6	Measuring Vent Lengths.....	13
Cap (see vent termination).....	20	Noise (see Normal Operating Sounds).....	34
Chimney Cap (see vent termination)	20	Normal Operating Sounds	34
Clearances	8	Packing List.....	7
Condensation on Glass.....	32	Piping Installation (see Gas Line Install)	11
Corner Installation	8	Restrictor Position.....	13
Dimensions	6	Safety Label	39
Elbows.....	13	Safety Precautions.....	4
Finalizing the Installation.....	23	Starting the Stove for the First Time	32
Floor Protection	9	Thermostat Operation.....	32
Fuel	4	Turning the Stove On and Off.....	32
Gas Inlet Pressure	11	Vent Length (see "Vent Config.").....	13
Gas Line Connection	11	Vent Requirements	11
Gas Line Install	11	Vertical Vent Termination Requirements.....	20
Gas Smell.....	See Inst. on Cover	Warnings.....	4
Glass Installation and Removal	25	Warranty	40
Hearth Requirements.....	9	Water on Glass (see Condensation)	32
Heating Specifications	6	Weight.....	6
Horizontal Vent Termination Requirements.....	20	Wiring Diagram	38
		Yearly Service Procedure	36